

Our choices matter.

**To our families, our communities,
and generations to come.**

**Together,
our choices
are powerful.**

**Thank you for helping us create a safe, fair, and
transparent marketplace.**

CR Consumer
Reports®

SAFETY ALERT: READ THIS BEFORE YOU USE YOUR GENERATOR

DECEMBER 2019

CR Consumer Reports®

REVIEWS & RATINGS

- Dishwashers
- Sound Bars
- Chainsaws
- Snow Blowers
- Laptops

GET SMART ABOUT SUPPLEMENTS

Our testing and advice help you shop safely for these largely unregulated products.



■ PLUS

WHEN PRODUCT RECALLS FAIL AND HOW TO PROTECT YOURSELF

GREAT GIFTS UNDER \$50

TOP TIRE PICKS AND BEST-PRICED RETAILERS

Your Road Map to Easy Car Shopping

Looking to save money and avoid car-buying hassles? Get the deal you want with the Build & Buy Car Buying Service®. Buyers have seen an average savings of \$3,016 off MSRP* from a nationwide dealer network.



SEARCH for the car you want and see what others paid



LOCATE the dealership from our prescreened network of over 15,000



COMPARE real pricing from participating dealers



SAVE and drive home your car and your savings!

Take a test drive at [cr.org/buildandbuy](https://www.consumerreports.org/buildandbuy)

CR Consumer Reports®

*Between 7/1/18 and 9/30/18, the average savings off MSRP presented by TrueCar Certified Dealers participating in the Consumer Reports Build & Buy Car Buying Service, based on users who received in-stock price offers and who TrueCar identified as purchasing a new vehicle of the same make and model as one of the in-stock price offers from a Certified Dealer as of 10/31/18, was \$3,016. Your actual savings may vary based on multiple factors, including the vehicle you select, region, dealer, and applicable vehicle-specific manufacturer incentives, which are subject to change. The MSRP is determined by the manufacturer and might not reflect the price at which vehicles are generally sold in the dealer's trade area as not all vehicles are sold at MSRP. Each dealer sets its own pricing.



Making Sense of Supplements

Sixty-eight percent of Americans take supplements at least once a week, but what's inside might not be effective—or even safe.

P. 26

26 Shop Smarter for Supplements

In this mostly unregulated market, consumers are largely left to fend for themselves. To help guide you, we examine medical research and put some botanical products to the test. Learn how to shop more safely and wisely.

38 Generator Safety Guide

Improperly using your generator could expose you to deadly gas hazards. We've updated our ratings based on brand-new risk-reducing technology. Plus, our safety guide provides specific steps to protect you and your family.

RATINGS

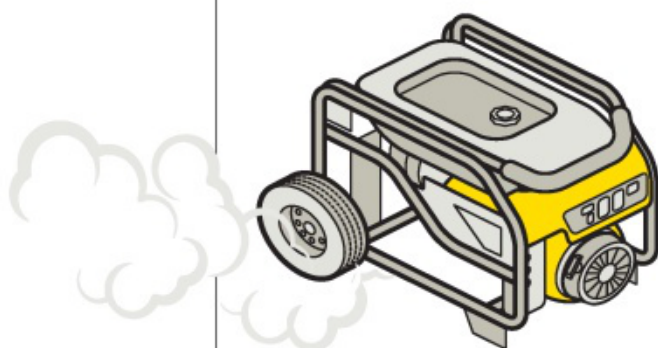

42 When Recalls Fail

Why are faulty and dangerous devices and products still being used by consumers and sold in stores? We take a close look at the weaknesses of our current recall system—as well as what needs to change.

PRODUCTS RATED IN THIS ISSUE



SNOW BLOWERS

P. 11



SLOW COOKER

P. 14



LAPTOPS

P. 20



TIRES

P. 56



AUDI A6

P. 59

Contents



P. 52

Making Tracks
Our unparalleled, rigorous testing reveals what's tops in tires.

IN EVERY ISSUE

6 From the President: What's Wrong With Recalls

Help us get dangerous products out of stores and homes.

7 Building a Better World, Together

A push for more zero-emissions electric vehicles, honest meat labels, and kids' privacy.

8 Your Feedback

Readers' comments about our recent content.

62 Index

63 Selling It

Goofs and gaffes.

ROAD REPORT

51 Ahead of the Curve

Auto ratings, news, and advice.

52 The Wheel Deal

Expert tips from the best tire testing program on the planet.

RATINGS

59 Road Test

We test the Audi A6, Ford Explorer, Hyundai Palisade, and Nissan Leaf Plus.

RATINGS

DEPARTMENTS & COLUMNS

10 What We're Testing in Our Labs ...

Air mattresses for houseguests, TV sound bars, dishwashers, and more.

RATINGS

12 Ask Our Experts

Discover the best ways to use your convection oven, and where to install a smart thermostat. Plus: Last-minute tips for using 2019 flexible spending account funds.

13 CR Insights

Happy holiday gift shopping! We've gathered up some top-scoring products for \$50 or less.

RATINGS

PRODUCT UPDATE

18 The Laptop Has Landed

Discover powerful, versatile, budget-friendly models that literally bend over backward to meet your needs.

RATINGS



P. 18

ABOUT CONSUMER REPORTS

Consumer Reports is an independent, nonprofit organization founded in 1936 that works side by side with consumers to create a safe, fair, and transparent marketplace. To achieve our mission, we test thousands of products and services in our labs each year and survey hundreds of thousands of consumers about their experiences with products and services. We pay

for all the products we rate. We don't accept paid advertising.

In addition to our rigorous research, investigative journalism, and consumer advocacy, we work with other organizations, including media, consumer groups, research and testing consortiums, and philanthropic partners. We also license our content and data, as well as work with business partners to offer shopping and other consumer services,

and may receive fees from these programs. We maintain a strict separation between our commercial operations and our testing and editorial operations. Our testing and editorial teams decide which products to test and review; our external business partners or other third parties do not dictate or control these decisions. Lastly, these partnerships and programs do not constitute CR's endorsement of any products or services.

For more information go to [CR.org/about](https://www.consumerreports.org/about).

HOW TO REACH US Write to us at Consumer Reports, 101 Truman Ave., Yonkers, NY 10703, Attn.: Member Support.

TO SEND A LETTER TO THE EDITOR Go to [CR.org/lettertoeditor](https://www.consumerreports.org/lettertoeditor).

NEWS TIPS AND STORY IDEAS Go to [CR.org/tips](https://www.consumerreports.org/tips).

EMAIL SUBMISSIONS For Selling It send items to SellingIt@cro.consumer.org

or call 800-333-0663.

See page 63 for more details.

ACCOUNT INFORMATION

Go to [CR.org/magazine](https://www.consumerreports.org/magazine) or call 800-333-0663.

See page 5 for more details.

RATINGS Overall Scores are based on a scale of 0 to 100. We rate products using these symbols:

🔴 POOR 🟡 FAIR 🟢 GOOD
🟢 VERY GOOD 🟢 EXCELLENT

“ CR epitomizes the American spirit of individual choice and responsibility. Leaving a gift in our will helps us be a part of making sure that endures. ”



Frances and Roger support CR with a gift in their will.

To learn more or request our complimentary brochures on charitable gifts and estate planning, please contact Amanda Das at 877-275-3425 or legacy@consumer.org



Consumer Reports is a 501(c)(3) nonprofit organization.

CRM9CDEV



Member Support You can call us about your membership at 800-333-0663.

Or go to CR.org/magazine to • Renew or pay for your current magazine • Give a gift • Change your address • Report a delivery problem • Cancel your magazine

Or write to us: Consumer Reports Member Support
P.O. Box 2109, Harlan, IA 51593-0298
Please include or copy address label from issue.
(Allow four to six weeks for processing.)

Price In U.S., \$6.99 per issue, special issues \$7.99. In Canada, \$7.99 CAN per issue, special issues \$8.99 CAN (Goods and Services Tax included, GST #127047702). All other countries add \$10 per year to the U.S. price for shipping and handling.

Back Issues Single copies of previous 24 issues, \$7.95 each; previous two Buying Guides, \$14.49 each (includes shipping and handling). Please send payment to Consumer Reports, Attn.: Member Services, 101 Truman Ave., Yonkers, NY 10703. Other ways to get Consumer Reports on the go: Apple News+, Google Play, Kindle, Nook, Readly, and Zinio.

Permissions Reproduction of Consumer Reports in whole or in part is forbidden without prior written permission (and is never permitted for advertising purposes). For questions about noncommercial, educational/academic uses of our content, please submit requests to CRreprints.com.

Mailing Lists We exchange or rent our print postal mailing list so that it can be provided to other publications, companies, and nonprofit organizations that offer products or services through direct mail. If you wish to have your name deleted from our list, please send your address label with a request for deletion from outside use to Consumer Reports, P.O. Box 2109, Harlan, IA 51593-0298. We do not exchange or rent email addresses. You can review our complete privacy policy regarding Consumer Reports information products, services, and programs at CR.org/privacy.

Consumer Reports (ISSN 0010-7174) is published monthly, except twice in December, by Consumer Reports, Inc., 101 Truman Ave., Yonkers, NY 10703. Periodicals postage paid at Yonkers, N.Y., and at other mailing offices; Canadian postage, at Mississauga, Ontario (Canadian publications registration number 2665247, agreement number 40015148). Title Consumer Reports is a federally registered trademark in the U.S. Patent and Trademark Office. Contents of this issue copyright © 2019 by Consumer Reports, Inc. All rights reserved under international and Pan-American copyright conventions.

CR's No Commercial Use Policy To view the policy, go to CR.org/nocommercialuse.

Contributions Consumer Reports is an independent 501(c)3 nonprofit organization that works side by side with consumers to create a fairer, safer, and healthier world. Contributions are tax-deductible in accordance with the law. Donations of commonly traded securities or real estate will be accepted and immediately converted to cash. For additional information, email donorservices@cr.consumer.org. To donate, please send your tax-deductible contribution to Consumer Reports, Attn.: Donor Services, 101 Truman Ave., Yonkers, NY 10703 or go to CR.org/donate.

Charitable Gift Annuity Establishing a Consumer Reports Charitable Gift Annuity is an ideal way to accomplish your personal financial goals while supporting the mission of Consumer Reports. For additional information, please contact us at 877-275-3425 or legacy@consumer.org.

Consumer Reports' Staff operates under contract between Consumer Reports and The NewsGuild of New York Local 31003, CWA.

Members Send address changes to Consumer Reports, P.O. Box 2109, Harlan, IA 51593-0298. If the post office alerts us that your magazines are undeliverable, we have no further obligation to fulfill your magazines unless we have a corrected address within two years.

POSTMASTER Send all UAA to CFS (see DMM 507.1.5.2).

NON-POSTAL AND MILITARY FACILITIES Send address corrections to Consumer Reports, P.O. Box 2109, Harlan, IA 51593-0298.

CANADA POST If copies are undeliverable, return to Consumer Reports, P.O. Box 481, STN MAIN, Markham, ON L3P 0C4.



Consumer Reports is a member of Consumers International, a federation of more than 220 consumer organizations from more than 115 countries working to protect and empower consumers throughout the world. For information, go to consumersinternational.org.

Please Remember CR in Your Will For information about how to make a bequest to Consumer Reports, please contact us at 877-275-3425 or legacy@consumer.org.

What's Wrong With Recalls



EVERY DAY, WE make certain assumptions about the safety and quality of the products we live with. We hunt for bargains, read reviews, and assume that what we buy and bring into our homes has been tested and proved to meet sensible standards. We know some products will work better or last longer than others, but how often do we consider the ways in which our purchases could result in harm—

such as sickness, injury, or even death? If a product or food were reported to have hurt consumers, the manufacturer or government would surely let us know, right?

Not so fast. As unsettling as it is, it's important to know that under our current regulatory system, dangerous items are sometimes put on the market and remain on the shelves. A variety of federal agencies oversee different industries, and some are more empowered than others. For example, federal law generally requires the agency overseeing household products to get manufacturers' permission before releasing any identifying information about dangerous, or even deadly, products. The human costs of this broken system are impossible to ignore. Consider this stark example: It took a Consumer Reports investigation—prompted by the government's accidental release of case reports with product names—for Fisher-Price to recall its Rock 'n Play Sleeper even after the product was already tied to dozens of infant deaths. Why is it that companies can use massive amounts of data to market their products to us, but the data that could make us safer, and even save lives, is kept out of reach?

This month, we're pulling back the curtain on the world of product recalls—who makes the rules, where the system falls short, and what you can do to protect your family when regulators lag or fail to keep you safe. We need our government watchdogs to watch out for us, but when they don't, CR is on guard to make sure the market is safe, fair, and transparent for all of us.

Marta L. Tellado,
President and CEO
Follow me on Twitter
[@MLTellado](#)

President and CEO Marta L. Tellado

Senior Vice President, Chief Operating Officer Leonora Wiener
Vice President, Chief Content Officer Gwendolyn Bounds

Editor in Chief Diane Salvatore
Executive Editor Kevin Doyle Features Editor Natalie van der Meer

Design Director Matthew Lenning Creative Director, Brand Young Kim
Associate Design Director Mike Smith
Art Directors Ewelina Mrowiec, Michael Solita
Photo Editors Lacey Browne, Emilie Harjes, Karen Shinbaum

Senior Director, Content Development Glenn Derene
Deputy Directors, Content Development Christopher Kirkpatrick, Ellen Kunes
Associate Directors, Content Development Scott Billings, Althea Chang
Senior Director, Content Impact & Corporate Outreach Jen Shecter
Special Projects Joel Keehn, Director; Margot Gilman, Associate Director; Lisa L. Gill, Rachel Rabkin Peachman, Deputies; Ryan Felton, Donna Rosato, Writers
Editorial Director, Digital Erle Norton
Senior Director, Product Testing Maria Rerecich

CARS: *Editors/Writers:* Keith Barry, Jeff S. Bartlett, Jonathan Linkov, Mike Monticello, Jeff Plungis *Auto Test Center:* Jake Fisher, Jennifer Stockburger, Directors
Product Testing: Michael Bloch, Steve Elek, Kelly Funkhouser, John Ibbotson, Chris Jones, Anita Lam, Gene Petersen, Ryan Pszczolkowski, Mike Quincy, Gabriel Shenhar, Shawn Sinclair, Emily A. Thomas, Joe Veselak

HEALTH & FOOD: *Editors/Writers:* Jessica Branch, Trisha Calvo, Lauren F. Friedman, Kevin Loria, Catherine Roberts, Diane Umansky

HOME & APPLIANCE: Eric Hagerman, Content Lead *Editors/Writers:* Daisy Chan, Mary Farrell, Paul Hope, Kimberly Janeway, Sara Morrow, Haniya Rae, Perry Santanachote, Daniel Wroclawski *Product Testing:* John Galeotafiore, Emilio Gonzalez, James Nanni, Testing Leads; Peter Anzalone, John Banta, Susan Booth, Tara Casaregola, Lawrence Ciufo, Enrique de Paz, Bernard Deitrick, Cindy Fisher, Rich Handel, Misha Kollontai, Ginny Lui, Joan Muratore, Joseph Pacella, Christopher Regan, Frank Spinelli, Dave Trezza, Michael Visconti

MONEY: *Editors/Writers:* Octavio Blanco, Tobie Stanger, Penelope Wang
Policy Lead: Anna Laitin

TECH: Jerry Beilinson, Content Lead *Editors/Writers:* Nicholas De Leon, Bree Fowler, Thomas Germain, Christopher Raymond, Allen St. John, Jake Swearingen, James K. Willcox *Product Testing:* Richard Fisco, Robert Richter, Testing Leads; Elias Arias, Antonette Asedillo, Claudio Ciacci, Charles Davidman, Cody Feng, Henry Parra, Richard Sulin, Maurice Wynn *Policy Lead:* Justin Brookman

Chief Scientific Officer James H. Dickerson
Food Safety James E. Rogers, Director; Tunde Akinleye, Amy Keating, Ellen Klosz, Sana Mujahid, Charlotte Vallaey
Product Safety Don Huber, Director; Doris Sullivan, Associate Director

Content Operations Robert Kanell, Director
Premedia William Breglio, Associate Director; Eugene Chin, William Hunt, Anthony Terzo
Production Nancy Crowfoot, Associate Director; Eric Norlander, Manager; Diane Chesler, Letitia Hughes, Terri Kazin, Aileen McCluskey
Copy Editing Leslie Monthan, Copy Chief; Noreen Browne, Alison France, Wendy Greenfield
Fact Checking and Research David Schipper, Associate Director; Tracy Anderman, Joy Crane, Sarah Goralski, Christine Gordon, Karen Jacob, Jamison Pfeifer

Photography John Powers, John Walsh
Imaging Francisco Collado, Mark Linder

Chief Research Officer Kristen Purcell
Consumer Engagement Testing Charu Ahuja, Director; Samuel Chapman, Linda Greene, Dana Keester
Statistics & Data Science Michael Saccucci, Director; Andrew Cohen, Kristen Dorrell, Dina Haner, Keith Newsom-Stewart
Survey Research Karen Jaffe, Simon Slater, Associate Directors; Dave Gopoian, Kendra Johnson, Debra Kalensky, Martin Lachter, Jane Manweiler, John McCowen, Adam Troy, Tess Yanisch

Consumer Insight Monica Liriano, Associate Director; Joey Edwards, Selina Tedesco, Teneisha Thomas, Frank Yang
Member Support Sue Melfi, Director; Donna Murianka
Marketing Dawn Nelson, Senior Director; Patricia McSorley, Newsstand
Procurement Operations Steven Schiavone, Associate Director
Administration Decarris Bryant

VICE PRESIDENTS: Chief Communications Officer Matt Anchin;
Financial Planning & Analysis JoAnne Boyd; Chief Human Resources Officer Lisa Cribari; Chief Digital Officer Jason Fox; Advocacy David Friedman; Chief Intelligence Officer Esther Han; General Counsel Michael Hubner; Development Geoffrey MacDougall; Research, Testing & Insights Liam McCormack; Business Strategy & Planning Betsy Parker; Chief Social Impact Officer Shar Taylor; SVP, Chief Financial Officer Eric Wayne

Protecting Kids' Privacy

WHAT'S AT STAKE

Everyone who uses the web has reason to be concerned about online privacy. But children are especially vulnerable to privacy violations at the hands of online marketers, data brokers, and identity thieves.

That's why a federal law, the Children's Online Privacy and Protection Act, requires that websites and apps get parents' consent before collecting personal information from kids younger than 13.

HOW CR HAS YOUR BACK

CR was one of the groups that pressed Congress to pass COPPA in 1998, and we worked with the government officials who updated the rules in 2012.

We were also part of a coalition that alleged that Google-owned YouTube was collecting information about kids without parental consent and using it to target ads. In April 2018 the coalition filed a complaint with the Federal Trade Commission. And in a September 2019 announcement that echoed many of the coalition's arguments, the FTC said Google and YouTube would pay \$170 million to settle allegations of violating COPPA (which the companies neither admit nor deny).

CR is pleased that the FTC took action. But even though it was the largest civil penalty the FTC has ever obtained in a children's privacy case, we don't believe the punishment goes far enough to prevent future wrongdoing.

WHAT YOU CAN DO

For tips and tools for protecting your—and your kids'—online privacy, read "Your Guide to Digital Privacy" in the October 2019 issue. And to learn more about how CR is helping, including the work of our new Digital Lab, go to [CR.org/dataprivacy](https://www.consumerreport.org/dataprivacy).

Keeping Meat Labels Honest

WHAT'S AT STAKE

The average U.S. adult consumes about 21 pounds of processed meats per year, from deli meats to hot dogs to bacon. The problem, as reported in our October 2019 article "Danger at the Deli," is that the curing process used to enhance the flavor and color (and extend the preservation) of these products results in nitrite levels that have been linked to cancer.

What's more, CR's latest testing of 31 deli meats found that processed meats cured with nitrates and nitrites from natural sources had about the same amount of the chemicals as those cured with synthetic ones. That's important because current Department of Agriculture rules require meat cured using nonsynthetic

sources, such as celery powder, to be labeled "uncured" or "no nitrates or nitrites added," creating the false impression of a safer or healthier product.

HOW CR HAS YOUR BACK

With our colleagues at the Center for Science in the Public Interest, CR submitted a petition to the USDA requesting a change to the misleading labeling rules. The petition, currently under review by the USDA, asks the agency to prohibit the 'uncured' and 'no nitrates or nitrites added' labels on meats processed using nonsynthetic sources of these chemicals. Instead, we're asking for clear front-of-package labeling whenever they're added, regardless of the source. More than 32,000 CR members have signed the petition.

WHAT YOU CAN DO

To add your name, go to [CR.org/curedmeatpetition](https://www.consumerreport.org/curedmeatpetition). And stay up-to-date on food safety at [CR.org/foodsafety](https://www.consumerreport.org/foodsafety).

Pushing for EV Choices

WHAT'S AT STAKE

In August, Colorado became the 11th zero-emissions-vehicle (ZEV) state, after passing rules requiring automakers to sell a growing share of electric vehicles (EVs) each year. EVs are cheaper to fuel and maintain than gas-fueled alternatives, and help to reduce smog and carbon pollution. Plus, a recent CR survey found that most prospective car buyers in Colorado are interested in EVs. Advocates of the program believe it will give consumers more zero-emissions options sooner, including SUVs and pickup trucks.

HOW CR HAS YOUR BACK

CR mobilized Colorado members to testify before the state's Air Quality Control Commission in support of the new standard, and CR policy advocate Shannon Baker-Branstetter served as an expert witness during the rulemaking process. The measure was approved by an 8-1 vote, with commissioners citing the overwhelming public support from written submissions and in-person testimony as a driving force.

CR also released a report in September finding that several states are taxing EV drivers at rates much higher than the average driver pays in gas taxes, which is an ineffective way to make up for highway fund shortfalls and punishes drivers for choosing ZEVs over gas-burning alternatives.

WHAT YOU CAN DO

To learn more about electric cars and see CR's ratings of eight current EVs, read our special report "The Electric Car Comes of Age" in the September 2019 issue or at [CR.org/evs1219](https://www.consumerreport.org/evs1219).

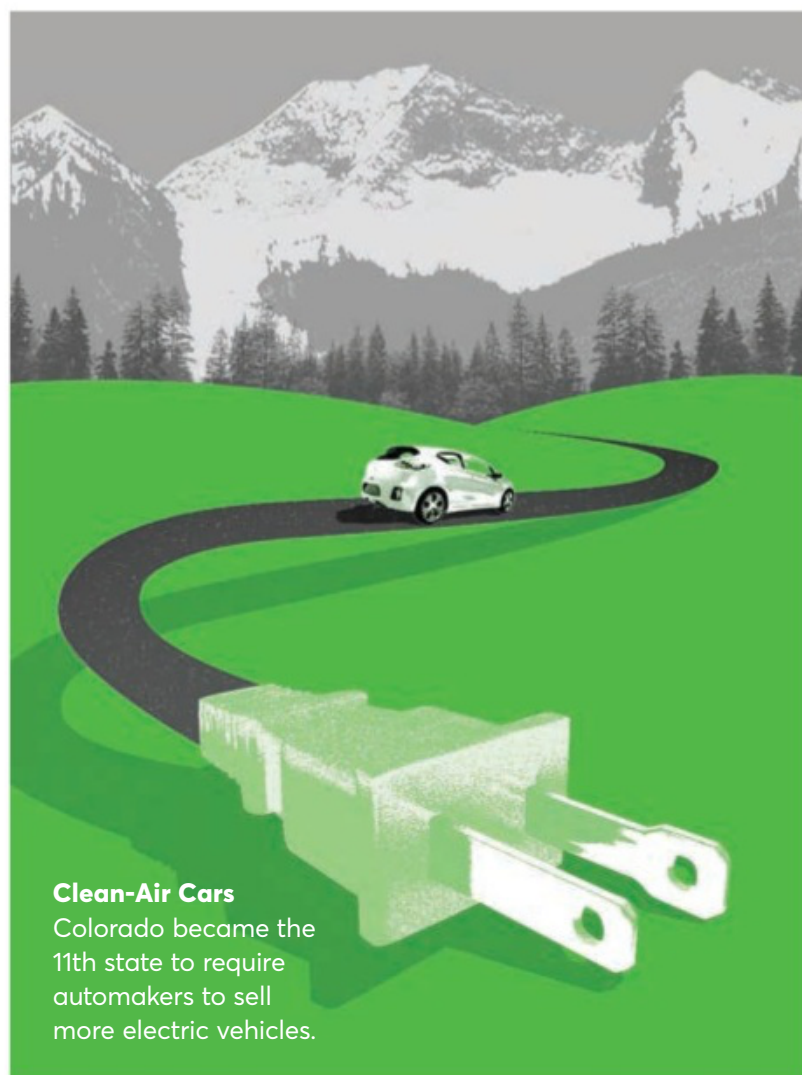

Clean-Air Cars

Colorado became the 11th state to require automakers to sell more electric vehicles.



Our October 2019 article **“Your Guide to Digital Privacy”** revealed the everyday objects in your life that may be spying on you—from smart speakers to fitness trackers—and offered smart ways to protect your personal data. To join the conversation, go to [CR.org/privacy1219](https://www.consumerreports.org/privacy1219).

THANK YOU, thank you, thank you for your October issue on cybersecurity! I’ve been trying to find good advice on each of the topics you covered. I’ll now be spending some time going through two MacBooks, two iPhones, and one iPad, and many apps and websites, doing as much cleaning up, sanitizing, and securing of my data as I can. I recently Googled my name and was astounded to see how much of “me” was out there! Fortunately, nothing too private (yet?), but there are

too many things I’ve used in the past as “secure” log-in words. Rather than slapped and fined, Google, Amazon, Facebook, et al., should be required to disclose up front, in simple English, what their policies are.
—Don Vogt, Santa Barbara, CA

THE ARTICLE ON digital privacy asserted “what’s most important is having strong, unique passwords for each account.” Will that protect someone when an entire server (e.g., Facebook, the Pentagon, Twitter, etc.) is hacked?
—Jessea Greenman, Oakland, CA

EDITOR’S NOTE Data breaches are unfortunately common, and can give hackers access to a lot of information, potentially

including passwords. Still, if you avoid reusing the same password for multiple services, a severe breach on one system is less likely to affect another.

IN YOUR EXCELLENT report on digital privacy, you mention the need for long passwords but do not define what “long” means. I’ve read that 12 digits is a minimum password length to use. BTW, my router password is more than 35 characters long. It’s a pain to use sometimes, but I don’t think it will be cracked!
—Matt Pey, Bordentown, NJ

EDITOR’S NOTE The National Institute of Standards and Technology (NIST) suggests that passwords be between eight

and 64 characters. That’s a big window, but it helps to choose something as long as you can handle. That’s because the more characters you use, the more possible passwords a hacker needs to contend with. But in addition to being long, make sure the password is complex and hard to guess.

I RECENTLY EXPERIENCED a four-day internet outage that affirmed my preference for a not-so-smart home. That would have been a catastrophe if everything was internet-dependent! Communications and streaming absences were bad enough.
—Jane Gordon, Portland, OR

I READ WITH great interest your article on digital privacy and efforts to keep our information safe. But nowhere do I see any evidence of efforts to keep our medical devices safe. Are there any efforts out there to protect our insulin pumps, pacemakers, and more from being hacked? Think about all the exposure for people with all the new internet-connected devices ... Yikes!
—Linda Kelly, Kingman, AZ

EDITOR’S NOTE Those devices could potentially be compromised, yes, but efforts are being made to prevent that. In fact, the Food and Drug Administration sometimes sends out cybersecurity security warnings when it sees a potential problem. For example, in June the FDA issued a caution about some older insulin pumps and recommended that people using those products seek replacements. And in January, a public-private consortium put out the Medical Device and Health IT Joint Security Plan, which advises healthcare entities and device makers on ways to minimize security risks for connected medical devices.



WRITE

Go to [CR.org/lettertoeditor](https://www.consumerreports.org/lettertoeditor) to share your comments for publication.



A MEATY DISCUSSION

YOUR ARTICLE “Danger at the Deli” (October 2019) made me pause and take notice. Like most consumers, I assumed the fresher the product, the less concerned one had to be regarding contamination. I’m a regular consumer of fresh sliced deli meats, and my favorite choices are well-advertised national brands. I’ve occasionally witnessed one of the two brands go bad in my fridge after several days, which had me convinced that preservatives were not part of the equation. My assumption is incorrect, obviously. Thanks for getting the word out.

—Robert Miller, Port Orchard, WA

DO YOUR WARNINGS about deli meat include the meat sliced to order at the deli counter in a chain store supermarket, or do the warnings apply to only presliced packaged and prepackaged meat?

—James Austin, San Diego, CA

CONNECT WITH US

FACEBOOK
fb.com/consumerreports
fb.com/SomosCR

YOUTUBE
/consumerreports

INSTAGRAM
@consumerreports

TWITTER
@consumerreports
@SomosCR

PINTEREST
/consumerreports

LINKEDIN
/company/
consumer-reports

EDITOR’S NOTE We tested for *Listeria monocytogenes* only in cold cuts sliced at the deli counter. Packaged deli meats aren’t immune from contamination, but the chances are higher in sliced meat, often due to in-store contamination. The risks from nitrates and nitrites, however, are the same in both deli-sliced and packaged processed meats. Though we didn’t test for these compounds in sliced meat, both are preserved with nitrites or nitrates. And both can have high levels of sodium.

RE: IMPOSSIBLE AND Beyond Meat Burgers (“Meat Gets a Makeover,” October 2019). It’s about the insane cruelty of factory farming. It’s about saving the lives of the billions of animals [that die] for the sake of appetite. It’s about saving the rainforests as well as the earth. Just saying.

—Shelley Butler, via CR.org

ONE OF BEEF’S major environmental impacts is water consumption. Most U.S. beef is raised in arid western states. Beef and hay are enormously water consumptive. In Utah, 82 percent of water is used by Big Ag and about three-quarters of that goes to cattle/forage. Alfalfa is Utah’s largest crop, using far more water than all cities/towns combined. Western state populations are exploding and demanding more water. We’ll have to decide between cows and kids.

—Chuck Shaw, Escalante, UT

GIANT PORTOBELLO mushrooms, gently sautéed on both sides in olive or avocado oil for just a few minutes with a touch of low-sodium soy sauce or Bragg liquid aminos, are incredibly delicious and make great burger substitutes! Can’t stay away from them.

—Norma Sandler, via CR.org



READERS BITE INTO PLANT BURGERS

I’ve tried the Beyond Burger at Carl’s Jr. three times, and each time it was cooked perfectly, and I genuinely couldn’t taste the difference between it and a regular Carl’s Jr. “Famous Star with Cheese” burger, which really surprised me. For those without legume allergies, this is a great alternative to a ground beef burger.

—Ann Detsch, via CR.org

I tried the brand-name plant-based sandwich at Burger King called the Impossible Whopper. My partner and I did a blind taste test, comparing it with the standard Double Whopper. Could we tell the difference between the two? Oh, hell yes, we could! The Impossible Whopper was dull and tasteless. They’re going to have to do some work on it before I try it again.

—Jim Brown, via CR.org



AVOIDING DEER

PER YOUR ARTICLE “How Likely Are You to Hit a Deer?” (Insights, October 2019): In a deer area, tailgating drivers are a real menace. If you have to suddenly brake because a deer has jumped into the road ahead of you, the tailgating driver behind you can’t possibly stop safely. I slow down to let tailgating drivers go past.

—Chris Rickwood, Surrey, British Columbia

SITTING SAFELY IN THE CAR

RE: “THE RIGHT WAY TO Sit Behind the Wheel” (Insights, October 2019). To wit: I feel that CR should have included a warning about passengers not putting their feet on the car’s dashboard as if it was a footrest.

—Gene Zagorsky, Flushing, NY

EDITOR’S NOTE You’re absolutely right. Passengers should never place their feet on the dashboard, because the force of a deploying airbag can drive their legs back, risking injury to their legs and to other parts of their bodies, including their heads and face, if their legs strike them.

NOTE: In our October story “Meat Gets a Makeover,” we should have specified that Just’s research focused only on the company’s plant-based products. There are still no large-scale studies on what impact lab-grown meat may have on the environment.

What We're Testing in Our Labs ...

In our 63 labs, we continually review and rate products. Here, timely picks for this month.

Travel-Size Humidifiers

WE TESTED: 6 models
WE TEST FOR: Ease of operating and maintaining a unit, number of gallons emitted daily per square foot, how noisy a unit is, energy efficiency, and more.

ABOUT THE SCORES:
Median: 80
Range: 26-87

Works With Any 20-Ounce Water Bottle as the Tank

Hunter QLS-03
\$30



87
OVERALL SCORE

Long Wall-Plug Cord

Well at Walgreens Personal Humidifier
\$30



83
OVERALL SCORE

Can Be Charged by USB

Crane EE-5950
\$30



82
OVERALL SCORE

Sound Bars

WE TESTED: 26 basic models
WE TEST FOR: Sound quality, including tonal accuracy and the ability to reproduce fine sonic detail; how easy a model is to set up and use with a TV; and more.

ABOUT THE SCORES:
Median: 50
Range: 20-65

Best Overall & 2-Year Warranty
Yamaha YAS-207BL
\$230



65
OVERALL SCORE

Very Easy to Use With a TV

Klipsch RSB-11
\$600



60
OVERALL SCORE

Bargain Buy

Creative Stage 2.1
\$90



57
OVERALL SCORE

Ask Our Experts

TV technology is better than ever—so why are we still being sold sound bars?



Though sound quality on TVs—especially on high-end models—has improved in recent years, “many more affordable sets still don’t match the experience that even a decent sound bar can deliver,” says Claudio Ciacci, CR’s TV tester. (Superior sound technology can be expensive, and on some sets, it’s not prioritized.) As a result, the majority of the 200 or so TVs we test get only a Good or Fair rating for sound. We hold sound bars to a higher sound standard than TVs. So a sound bar with a Good rating will deliver richer sound than a TV with a Good sound rating. Our tests reveal that even a low-cost model (such as the Creative bar above) can enhance your TV listening experience.

ILLUSTRATION: SERGE BLOCH

For the latest ratings of these and other product categories, readers with a Digital or All-Access membership can go to [CR.org](https://www.crisp.com).

Dishwashers

WE TESTED: 76 models
WE TEST FOR: How well a model washes a full load of dishes with baked-on food when set to a normal cycle, how thoroughly a model dries items, noise, and more.

ABOUT THE SCORES:
 Median: 71
 Range: 36-88

Fastest (95 Minutes)
 Bosch Ascenta SHX3AR75UC
 \$625

88
 OVERALL SCORE



Quietest
 Thermador DWHD660WFP
 \$1,800

84
 OVERALL SCORE



Self-Cleaning Filter
 KitchenAid KDTM354DSS
 \$775

82
 OVERALL SCORE



Chainsaws

WE TESTED: 30 models
WE TEST FOR: How fast a chainsaw can cut through a 10-inch-square oak beam; handling; safety, including kickback intensity; ease of use; and more.

ABOUT THE SCORES:
 Median: 66
 Range: 24-80

Heavy-Duty & 5-Year Warranty
 Echo CS-590-20 (gas)
 \$400

80
 OVERALL SCORE



Lightweight for Small Jobs
 Stihl MS 180 C-BE (gas)
 \$250

80
 OVERALL SCORE



Powerful Battery
 Dewalt DCCS670X1
 \$330

79
 OVERALL SCORE



Air Mattresses

WE TESTED: 4 double-height models
WE TEST FOR: How much a mattress sinks when a heavy load is placed on it for more than 15 minutes, how quickly a mattress inflates, and more.

ABOUT THE SCORES:
 Median: 67
 Range: 43-81

Best for Any Guest
 Simmons Beautyrest Hi Loft Raised (62W x 83L)
 \$68

81
 OVERALL SCORE



Extra Wide
 Intex Comfort Plush Elevated Dura-Beam (65W x 83L)
 \$50

74
 OVERALL SCORE



Longest Warranty (1 Year)
 Insta-Bed Raised Air Mattress (61W x 81L)
 \$110

60
 OVERALL SCORE



Snow Blowers

WE TESTED: 14 single-stage gas models
WE TEST FOR: How quickly a model can remove snow without laboring, throwing distance, ease of handling and controls, and more.

ABOUT THE SCORES:
 Median: 65.5
 Range: 38-78

Speedy Snow Removal
 Toro 824 QXE 36003
 \$880

78
 OVERALL SCORE



Great Value
 Troy-Bilt Squall 179E
 \$450

66
 OVERALL SCORE



Throws Snow Farthest (Useful for Wide Driveways)
 Simplicity 1022EE
 \$600

62
 OVERALL SCORE



Note: We rate different products according to different testing protocols; as a result, Overall Scores of one product category are not comparable with another.

COMING NEXT MONTH Coffee Grinders & More



When should I use my oven's convection function?

Many newer ranges and wall ovens offer a convection setting, typically with two modes: baking and roasting. When you turn on either of these modes, one or more fans inside the oven cavity circulate hot air while your food cooks. (Certain ovens also have an extra heating element, often dubbed “true” convection.) Manufacturers claim this helps to heat and brown food more evenly, and can reduce the overall cooking time.

But in practice, that’s not always the case. “The success of convection baking in our tests is hit or miss,” says Tara Casaregola, Consumer Reports’ test engineer for ranges and wall ovens. “Some ovens, such as the LG LRG3193ST, do better with convection baking mode

turned on, but others do best simply on the conventional bake setting.” Casaregola adds that in some cases, the same oven might convection-bake beautiful cookies but still botch a cake.

She advises referencing the owner’s manual for your range. Some instruct you to shorten the cook time or reduce the temperature when using convection mode. It’s a good idea to do a test run of a favorite baking recipe to see how it affects your bake.

However, convection roasting (which may have a different name, such as Pure Convection, depending on the brand) is another story. This additional convection setting, offered on models such as the GE Profile PB911SJSS, is best for crisping and browning large cuts of meat, and is less fickle. When using convection roast, you can generally turn down the oven temperature 25° F below what the recipe calls for, and start testing for doneness earlier than you might think, until you’re accustomed to how your oven handles the job.

I haven’t spent all the funds in my flexible spending account for the year yet. What can I still do?

There’s plenty you can do with your FSA money so that you don’t lose it. With an FSA, which you can get only through an employer, you put pretax money away to spend on qualifying medical expenses not covered by your health insurance. Putting money into an FSA is a smart way to reduce your taxable income and cover healthcare costs, says Donna Rosato, a CR senior money editor.

Though many employers require you to spend the money by Dec. 31, some companies give you additional time, Rosato says, so check with yours. For 2019, 30 percent of employers that offer FSAs give up to an extra two and a half months to spend FSA money, and 43 percent allow you to carry over up to \$500 into the next year, according to a survey of 2,763 human resources professionals.

If you do have an end-of-year deadline, don’t panic. A huge variety of services and products, from acupuncture and allergy testing to lip balm and sunscreen, are FSA-eligible. Go to FSASTore.com to see what qualifies. Almost

everything sold on the site is eligible for FSA dollars. If you still find yourself struggling to spend it all, consider contributing less next year.

I’m getting a smart thermostat. Does it matter where in the house I place it?

The ideal placement of any thermostat is on an interior wall in a common space, away from anything that could create temperature extremes, such as direct sunlight, a drafty window, or an air vent. Avoid placing a thermostat in an isolated room that tends to get colder or hotter than the main part of the house. All of this helps the thermostat get a more accurate reading, says Peter Anzalone, who tests thermostats for CR.

The path of least resistance is to place your new thermostat in the same spot as the old one, where the wiring is. If it isn’t in an ideal location, you’ll need to pay an installer to rewire. But one easy, inexpensive solution (without rewiring) is to see whether your new smart thermostat is compatible with remote temperature sensors—small wireless devices that can be put in other rooms to monitor temperatures, enabling more balanced heating and cooling. The Nest Thermostat E, \$170, for example, offers separate Nest Temperature Sensors for \$39 each.

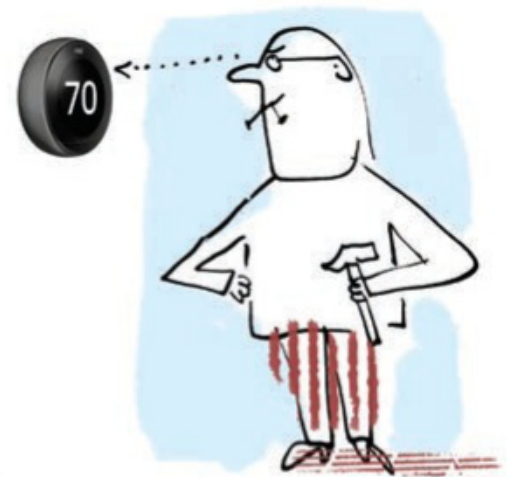

LEARN

We have more than 140 in-house experts who research, test, and compare. Submit your questions at CR.org/askourexper... and watch for the answers.

CR Insights



PHOTO: JOHN WALSH/CONSUMER REPORTS



GIFTS FOR \$50 AND UNDER

At CR, we take our stocking stuffers seriously—because we know that a well-priced, truly useful product can bring much joy. Browse our specially curated roundup of top-rated product suggestions, starting as low as \$15. And heed our shopping tips so that you know where and how to find deals safely.

**\$ WestBend 2-Slice
Black & Silver 78823
\$25**

84

This sleek toaster is a top performer, too: It passes our toasting evenness test with flying golden-brown colors and has a bagel setting to boot.

✓ **Amazon Basics Stainless Steel Electric Kettle** \$20

85



Great for any tea enthusiast, this quick-to-boil 4-cup kettle earns the second-highest score in our ratings.

💰 **Hamilton Beach 12-Cup Programmable 49465R** \$25

82



For coffee lovers on your list, here's a glass carafe brewer that serves up 12 excellent cups in just 10 minutes.

✓ **Brita Stream Rapids OB55** \$30

81



An ultra-practical pick, this Brita filters water quickly as you pour it into your glass—and is tops in our tests.

💰 **Artisanal Kitchen Supply Pre-Seasoned Cast Iron Skillet** (Bed Bath & Beyond) \$25

78



This sturdy, 12-inch cast-iron frying pan is a bargain and is excellent for searing steak and browning foods.

💰 **JLab Audio JBuds Air** \$50

76



Offering very good sound quality for the price, these completely wireless Bluetooth buds are a smart choice.

Vremi Dutch Oven \$45

73



This enameled cast-iron Dutch oven is excellent for baking bread and works on an induction cooktop.

Asobu Insulated Portable Brewer KB900 \$50

73



For the coffee-loving commuter, this brewer makes cold brew and keeps it chilled for on-the-go drinking.

Pioneer Woman 6 Quart Portable Slow Cooker 33362 \$40

68



This cooker turned out tender meat and veggies in our 5- and 8-hour beef stew tests. Plus, the insert is oven-safe.

STILL CONFUSED BY ...

5 THINGS TO KNOW WHEN SHOPPING ON AMAZON

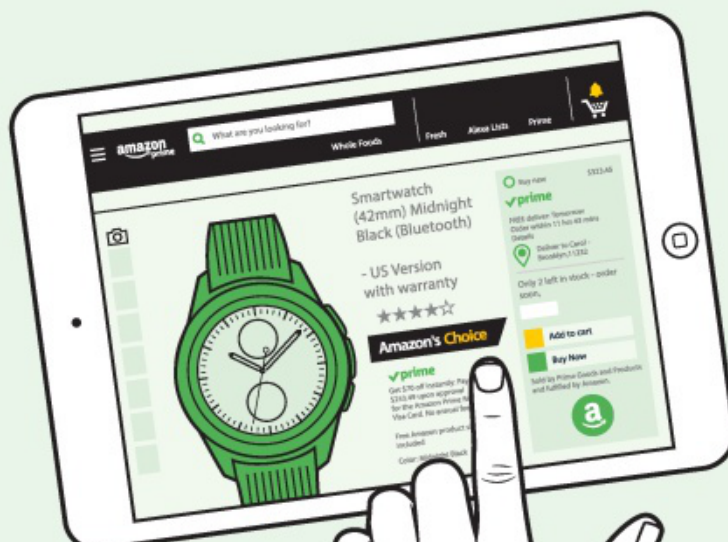

1. EVALUATE "AMAZON'S CHOICE"

As you search on Amazon, you'll see a black "Amazon's Choice" badge on some listings, which Amazon says "recommends highly rated, well-priced products available to ship immediately." That endorsement may sway you, but Amazon doesn't disclose exactly how it selects products within those guidelines, so don't assume that the product is of better quality or value without doing your own research.

2. CHOOSE YOUR SELLER WISELY

When you buy an item directly from Amazon, you'll see the phrase "Ships from and sold by Amazon.com" on the product listing. That means Amazon manages everything from shipping to customer service and returns. When you buy from a third-party seller, though, you might not get Amazon's typical 30-day full-refund return policy. Click on the seller's profile page link (under the "Add to Cart" and

\$ Black+Decker 3-in-1 Digital Power Crush BL1350DP-P Personal Blender \$50

77



The 2-cup personal attachment on this full-sized blender is excellent at whipping up single-serve smoothies.

✓ Scosche SportFlex 3 Headphones \$15

76



A nice idea for a jogger, these sporty corded headphones offer very good sound quality for a bargain price.

\$ Chefman Anti-Overflow Belgian Waffle Maker \$30

76



Turning out excellent waffles, this nonstick model has a moat to collect excess batter and prevent messy drips.

Cuisinart Smart Stick CSB-75 \$35

76



Powerful but small enough to fit in a drawer, this immersion blender is a thoughtful gift for any cook with a small kitchen.

Black+Decker 4-Slice TO1755SB \$33

66



Muffin lovers will thank you for this very good baking machine. It also excels at toast and has a two-year warranty.

Amazon Fire 7 (16GB) 2019 \$50

66



This sleek 6.9-inch tablet has roughly 8 hours of battery life—great for reading or watching movies.

\$ Canon Pixma MG3620 \$40

65



This low-cost all-in-one color printer offers up very good photo prints and doubles as a scanner.

Cuisinart Supreme Grind Auto Burr Mill DBM-8 \$50

58



Our highest-scoring grinder of those under \$100, this model holds 5.7 ounces of fresh coffee grounds and has 18 settings.

“Buy Now” buttons) to view that seller’s Returns and Refunds Policy. It’s also smart to look at the company reviews on the seller’s profile—they’ll help you see whether a seller tends to ship on time and sells quality products.

3. BEWARE OF “HIJACKED” REVIEWS

Rating stars indicate how many customers were satisfied (or not) with that specific item. But CR found that it’s worth digging into the written reviews as well. When we

looked at reviews for an iPhone charger, for example, the page included positive reviews for other products, such as a computer keyboard cleaner. These reviews, which were “hijacked” from other product listings, can inflate a product’s rating. (Amazon is aware of the issue and is trying to fix it.)

4. BE SAVVY ABOUT SHIPPING

Prime items, identified by the Prime logo under the listing, offer

members access to different shipping speeds: Some items have free standard shipping of four to five business days, and others offer the program’s signature two-day free shipping—though this means two business days after a product leaves the warehouse. So always check the estimated delivery date. Prime members in eligible ZIP codes may also see a same-day delivery option, but only if your order is

over \$35. (You may also see a countdown timer indicating the time by which you must place the order to receive your same-day delivery.)

Alternatively, if you don’t need the product right away, Amazon sometimes offers a reward or discount when you agree to receive your order in six business days with “No-Rush Shipping” at checkout.

5. PRACTICE DEAL DILIGENCE

Don’t forget to

comparison shop outside Amazon: You may find a better deal elsewhere. (In addition to competitive pricing, retailers such as Walmart now also offer two-day and next-day shipping on many items.) Amazon also has the ability to change prices frequently throughout the day, so it can pay to add a price tracker to your browser, such as Camelcamelcamel, that can show you a product’s price history and send you price-drop notifications.

Note: We rate different products according to different testing protocols; as a result, Overall Scores of one product category are not comparable with another.



FACE-OFF

HOLIDAY FOODS

CHAMPAGNE VS. COCKTAIL

All pure alcohol contains 7 calories per gram, and no other nutritional value. But that's just the beginning of the story. When you add in mixers like juice or "juice cocktail"—even healthy-sounding ones like pomegranate—you can easily drink more than the 100 calories that are in a 5-ounce glass of champagne. Plus, if you're not making it yourself, mixed drinks may contain more alcohol or added sugars than you realize. With a glass of champagne, on the other hand, what you see is what you get.

BETTER PICK: Champagne

There's no need to deprive yourself of all manner of treats this season. In fact, nutrition pros generally approve of enjoying festive dishes (in moderation) this time of year because when you deny yourself little indulgences, cravings may intensify. But even as you partake in festive splurges, you can make small adjustments that add up to a healthier holiday. Here's insight into a few choices you may encounter this season.

WHITE VS. SWEET POTATO

Both spud types are nutrient-rich and supply potassium, a mineral that blunts the impact of sodium on blood pressure, as well as vitamin C—and they aren't that different in carbohydrates or natural sugars. A white potato has some fiber, but one 4-ounce sweet potato provides 13 percent of your daily fiber needs and more than an adult's daily recommended dose of vitamin A. If you scoop up some sweet potato casserole, though, skip the marshmallow topping—there's plenty of better-for-you natural sweetness to savor without it.

BETTER PICK: Sweet potato

APPLE PIE VS. PUMPKIN

If you're treating yourself to a classic fall dessert, you know that extra calories, carbohydrates, and fat are all a given. But pumpkin pie, which offers vitamin A, will often have roughly 100 fewer calories per slice than apple pie. That's primarily because pumpkin pie has only a bottom crust while apple tends to have a top crust, too. More crust means more calories, as well as saturated fat from butter or shortening. If you're really craving apple, though, try a crisp, which swaps a white flour pie crust for a whole-grain topping.

BETTER PICK: Pumpkin pie

CR MONEY SAVER

CAN RETAIL MEMBERSHIPS SAVE YOU MONEY?

Retail membership plans are multiplying; these programs charge a fee in exchange for exclusive member perks and savings. In turn, the retailers hope you'll be more loyal and spend more with them. Before you sign up, ask yourself how often you'll use these services. With that in mind, weigh the cost against potential savings and other benefits, as well as the cancellation or auto-renew policy. Retailers may also track or share your data: To become a member, you may need to share your name, address, phone number, and other information, such as date of birth. Some may even track what you're buying and how often, and use that information to hone their business. So read any agreement carefully before you sign up.

To see the cost-benefit breakdowns of even more retail memberships, All-Access and Digital members can go to [CR.org/retail1219](https://www.consumerreports.org/retail1219).

Amazon Prime	AMC Stubs Premiere	Barnes & Noble Membership	Bed Bath & Beyond BEYOND+	CVS CAREPASS	Newegg PREMIER	Wayfair MYWAY
COST						
\$119/YEAR	\$15/YEAR	\$25/YEAR	\$29/YEAR	\$5/MONTH OR \$48/YEAR	\$19.99/THREE MONTHS OR \$29.99/SIX MONTHS OR \$49.99/YEAR	\$29.99/YEAR
SELECT BENEFITS						
Prime provides free one-day delivery on over 10 million items, free two-day delivery on over 100 million items on Amazon.com, and free same-day delivery in 5,000 cities and towns on select items. Plus access to Prime music, Prime video, and Amazon's Kindle Lending Library. Also: discounts at Whole Foods Market.	Online ticketing fees are waived for members, and you can go through priority lanes at AMC box office and concession stands. You'll also get free upgrades on popcorn and fountain drinks, free refills on large popcorn, and 100 rewards points for every \$1 spent (once you have 5,000 points, you'll get a \$5 reward).	When you sign up for a B&N Membership with Barnes & Noble, you'll get a variety of coupons. Membership includes 40 percent off hardcover best sellers, 10 percent off most other items, and free express shipping in one to three days.	Members receive free standard shipping on most items and 20 percent off all purchases made in stores or online. Members also receive 30 percent off Decorist, a website that offers online interior design services from professional decorators.	This pass offers 20 percent off CVS Health brand products and a \$10 monthly CarePass reward to use in-store or online. Members get free shipping on some items, free one- to two-day prescription delivery on qualifying prescriptions, and access to a 24/7 pharmacist hotline.	This online electronics store offers a membership for up to four people, with free three-day shipping and free returns with no restocking fees—plus exclusive deals and a dedicated customer-service line. Newegg offers a full refund if you haven't used any benefits in the current membership term.	Wayfair's membership gives you free shipping on all orders, 25 percent off product assembly (such as furniture), and exclusive sales offers. The membership also applies to the brand's sister companies: AllModern, Joss & Main, and Birch Lane.



THE BEST GIFT OF ALL We like to think of our magazine as a gift that keeps on giving all year long! For \$30, your recipient will receive a one-year gift (12 issues of Consumer Reports magazine) plus our Annual Buying Guide. Each gift also includes the annual Auto Issue plus a free holiday card that will be sent announcing your gift. After your first gift, additional gift subscriptions are only \$15 each. Go to [CR.org/crgift](https://www.consumerreports.org/crgift) to place your orders.

Note: Amazon, Bed Bath & Beyond, and Wayfair participate in CR's shopping program on CR.org. When you shop through their retailer links on our site, we may earn affiliate commissions. One hundred percent of the fees we collect is used to support our nonprofit mission.

Laptops surpass desktops in U.S. homes

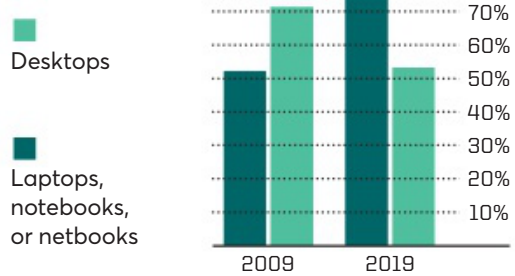

Source: Consumer Technology Association (CTA).

PRODUCT UPDATE

THE LATEST RATINGS FROM OUR LABS

The Laptop Has Landed

Move over, desktops. With power and speed in sleeker-than-ever packages, new laptops get the job done in style.

by **Nicholas De Leon**



INSIDE
CR'S LABS

Using a light meter, Artur Pietruch, a CR tester, measures the reflection from laptop screens.

SHOPPING FOR A COMPUTER used to be a pretty straightforward business: You picked a brand or maybe a screen size you liked and calculated how much storage space you could afford. The odds were good that a desktop was high on your list, especially if you wanted a lot of power. But as the design and performance of laptops improve, the appeal of their footloose freedom grows more appealing.

You can now find laptops that weigh 3 pounds or less, which makes carting one around all day practically effortless. Others stay powered for 16 to 18 hours on a single charge. And some even do double duty as tablets, shedding their keyboards so that you can curl up in bed with the touch-screen display and binge-watch episodes of “The Office.”

Even better news: If you were put off by the slow startup speeds of older laptops—one of the biggest pain points for Consumer Reports members, according to a recent survey—you’ll be happy to know that laptop makers are now shifting away from hard disk drives toward solid-state drives (SSDs), which are considerably faster at retrieving and writing data, says Richard Fisco, who oversees electronics testing at CR.

“When you double-click on an app like Word or Excel, it opens right up,” he explains. And that means less time staring at loading screens or spinning pinwheels and more time working, watching, and playing.

Is there a catch? Yes: Solid-state drives are more expensive (for the moment, at least). And they tend to come with less storage space for the money. Instead of 1 terabyte, which is becoming the norm in laptops with hard drives, you’re likely looking at 128 or 256 gigabytes. (There are 1,000 gigabytes in a terabyte.)

For most people, that’s still plenty, Fisco says. But if you’re accustomed to storing every snapshot and video

clip you’ve ever captured on your computer’s hard drive, you may want to consider investing in an external hard drive or cloud storage.

If your priority is computing power, it’s true that a desktop may give you slightly more power and performance for the buck. But today’s laptops pack more than enough oomph to browse the web, stream video, and run popular apps like Microsoft Word and Spotify without causing you to break a sweat—or break the bank.

If your computing chores aren’t complex, you can buy a powerful Windows-based laptop for as little as \$500. And you’ll find Chromebooks that perform similar feats—using Google’s Chrome OS operating system—for even less money. (To learn more about these, see page 20.)

Ready to test-drive one of these sleek devices in a store? A little hands-on time is a good idea, but prepare to be serenaded by salespeople about the wonders of other recent tech leaps, too, everything from 4K screens to gamer-friendly graphics cards. (See “5 Money Traps,” on page 22.) These pricey best-in-show features aren’t worth the extra investment for most consumers.

In fact, you don’t have to spend big money to get a laptop that suits your needs and is relatively problem-free (see our reliability chart at left). Thanks to our test labs, which evaluate dozens of new computers each year, this guide reveals the key factors—such as portability, versatility, battery life, and, yes, price—that add up to the perfect machine for your lifestyle. Our rigorous test protocol also assesses such elements as ergonomics, display quality, and processing speed. We even incorporate brand reliability and owner satisfaction into our Overall Scores. So if you’re ready to leap to a new computer, here’s what you need to know.

MOST & LEAST RELIABLE BRANDS

Everyone wants a long-lasting product, so should you invest in an extended warranty? According to a 2018 CR survey, the short answer is no. CR members who paid for extended warranties and service contracts rarely used them for repairs. And the median price paid for out-of-pocket repairs is relatively manageable: \$118 for PC laptops and \$165 for Apple laptops. Before you make the final call, though, it’s worth considering how the laptop brand you’re interested in stacks up when it comes to predicted reliability and owner satisfaction.

	Predicted Reliability	Owner Satisfaction
APPLE	⬆️	⬆️
LG	⬆️	⬇️
SAMSUNG	⬆️	⬇️
ALIENWARE	⬇️	⬆️
MICROSOFT	⬇️	⬆️
ACER	⬇️	⬇️
ASUS	⬇️	⬇️
DELL	⬇️	⬇️
HP	⬇️	⬇️
LENOVO	⬇️	⬇️
MSI	⬇️	⬇️
VAIO	⬇️	⬇️

Source: Consumer Reports 2018 and 2019 Winter Surveys.



LOW COST

Yes, you can find a fully functional laptop for \$500—or even less if you consider a Chromebook. Using Google’s Chrome operating system, the latter relies heavily on web-based apps and cloud storage to reduce the need for onboard storage and processing power. If you just want to check your email, stream, and browse, Chromebooks are a simple, lightweight (usually about 3 pounds), and inexpensive way to do so. They also tend to be reliable and offer more battery life than laptops for web browsing. One model in our ratings lasted more than 17 hours.

THE FLEXIBLE CHROMEBOOK

✓ Asus Chromebook Flip \$550

84

This 14-inch model is a 2-in-1 convertible, which means you can bend the keyboard back into a tented position, convenient for reading the news or watching movies. The battery lasts more than 12 hours for browsing. But the processor is an Intel Core m3, which is even slower than the i3 found in other Chromebooks.

THE BARGAIN CHROMEBOOK

💰 Acer Chromebook CB3 \$230

70

It’s not packed with power, but this 14-inch Chromebook delivers solid performance, especially given the low price. It can handle such basic tasks as email, Facebook browsing, and a little online shopping as long as you don’t keep too many tabs open at once, which can slow it down.

THE NICELY PRICED LAPTOP

✓ HP Pavilion 15 \$500

65

This traditional Windows laptop scores well in our performance tests, with more processing power and a bigger display than the Chromebooks above. A weak point is that the 15.6-inch display struggles with color accuracy and has a narrow viewing angle, so it’s not ideal for watching from the sides.



PORTABILITY

The big advantage of owning a laptop is that you can carry it from room to room as well as to the local coffee shop—and far beyond. Some models are so sleek and light that you can hold them in one hand like a clipboard. (And most don’t sacrifice battery life.) If travel is your priority, you might find your perfect companion below.

THE NEWCOMER

✓ LG GRAM \$1,300

76

LG is the industry’s new lightweight champ. This model has a 17-inch screen yet weighs just 2.9 pounds. Its performance rates Very Good, it has 512GB of storage space, and it offers 15.25 hours of battery life. (LG also makes a svelte 13-inch model at just 2.1 pounds.)

THE MAC FAN’S CHOICE

✓ MacBook Air \$1,100

73

At a mere 2.7 pounds, this 13.3-inch model reflects Apple’s pioneering success in the thin-and-light movement. The display is rated Excellent, the laptop has plenty of power for everyday tasks, and there’s enough battery power for 11.5 hours of web browsing. For some, though, the 128GB of storage space might be a tight squeeze.

THE FEATHERWEIGHT

Microsoft Surface Go (128GB) \$550

53

If you want a truly compact laptop, this 10-inch model weighs all of 1.7 pounds. The modest size requires some trade-offs, though. It’s fine for email and word-processing tasks, but it’s a little on the slow side. There’s limited storage space, too. But the battery lasts a good 10.25 hours.



2-IN-1 VERSATILITY

Today’s 2-in-1 models can transform to offer a tablet-like experience (though they’re much more powerful than a traditional tablet). With “detachables,” you simply remove the touch screen from the keyboard completely. “Convertibles” have hinges that let you fold the keyboard behind the screen or position it as a kickstand. That versatility has become a popular option. More than a quarter of the models we’ve tested fall into this category only seven years after the first popular 2-in-1, the **Lenovo Yoga**, debuted.

THE BIG-SCREEN CONVERTIBLE

✓ Dell XPS 15 \$1,600

73

This 15.6-inch convertible from Dell’s high-end laptop line scores well in our lab tests, turning in fast performance and good battery life for a model this size. The Intel Core i7 processor makes it well suited to demanding tasks such as video editing.

THE SPEEDY DETACHABLE

✓ Microsoft Surface Pro 6 \$800

68

Our testers praise the speed of this 2.4-pound Surface Pro, with its Intel Core i5 processor and high-quality touch-screen display that detaches to become a 12.3-inch tablet. The 128GB solid-state drive is on the small side, but you get a full day’s work out of the battery, even if you watch a video or two.

THE BARGAIN CONVERTIBLE

✓ Lenovo Flex 15 \$750

72

For half the price of the Dell above, this 15.6-inch convertible is a nice choice for those with everyday computing needs. It’s plenty fast for browsing the web and using office productivity apps such as Microsoft Excel, and it logged a solid 12.25 hours of web browsing in our battery-life test.

How to Turn Your Laptop Into a Desktop

If you've been accustomed to a desktop, you can still consider a laptop knowing that it's easy to turn it into a desktop configuration. With these accessories, you can place yourself properly at a desk but still unplug for maximum mobility when you need it.



MIND YOUR MUSCLES

Laptop users tend to work in settings that can contort the body: airplane seats, crowded coffee shops, porch swings, even a bed. Sitting at a desk instead encourages proper posture, especially if you sit with your feet flat on the floor, your arms at a 90-degree angle, and your elbows close to your torso. Reclining slightly can also help prevent backaches and fatigue. Try to take a 5-minute break from your computer chair every half-hour or hour.

A CLASSIC KEYBOARD

The keyboards on laptops are meant to be compact, so they aren't always comfy for hours of typing. (The "butterfly keyboards" on some Apple models have generated reliability complaints, too.) Alan Hedge, an ergonomics expert and professor emeritus at Cornell University, says that a shallow keyboard doesn't give your fingers adequate distance, or "travel," to type effectively. For more ease, use a larger, deeper external keyboard.

A BIG SCREEN

Richard Fisco, who oversees electronics testing at CR, says that a large external monitor should help you sit more comfortably. That's in part because you can easily adjust its orientation and placement so that the top of the screen is at eye level. Also, you don't need a pricey "docking station" to connect your laptop to a monitor. An inexpensive video cable should do, and a USB adapter if your laptop doesn't have an HDMI port.

A MIGHTY MOUSE

Some ergonomic mouse masterpieces can cost up to \$100, but you can spend less than half that for one that's more comfortable than your laptop's cramped track pad. If you're considering a wireless model, make sure to check the battery life and whether the mouse has rechargeable batteries. Also, take it for a test-drive, because hand size and scrolling style differ by person.



HOW TO BEAT BATTERY-LIFE BLUES

People depend on their laptops day and night, which is why we test the battery life on every model in our labs and factor it into our Overall Score.

The protocol our testers use is designed to resemble real-world use. With the battery fully charged, we cycle the laptop through a series of 10 web pages, downloading them continuously until the laptop runs out of power.

Then we recharge the battery and play a 4K video until the power drains once again. "It's a good way to gauge how well a battery will hold up during heavier workloads," says Antonette Asedillo, who oversees the testing.

Based on our results, you can readily find laptops that cross the 10-hour threshold. But it's difficult for consumers to know just how long a laptop battery will last simply by reading the specs, because manufacturers' claims are tied to their own test procedures. An HP Spectre Folio, which the company says offers up to 19 hours of battery life, stayed powered for 18.5 hours of web browsing in our tests, for example. But a Samsung Notebook 9 Pro with similar specs delivered just 8.5 hours, despite a claim of up to 14.7 hours.

In addition to looking at CR's test results, it helps to consider battery-taxing features as you shop. A solid-state drive is more energy-efficient than a hard drive, for instance, because it has no moving parts. And a 4K display will drain the battery life quicker than a 1080p screen, Asedillo says. The same goes for screen size. For longer-lasting power, go with a 13-inch display instead of a 15-inch.

5 Money Traps

These upsells can raise your purchase price needlessly. Our advice? Don't bite.



OVERPRICED DONGLES

In the feverish pursuit of thinner, lighter laptop designs, many computer makers have jettisoned old-school USB and Ethernet ports in favor of a smaller USB-C port. That means you might need to buy dongles (or adapters) that plug into your new laptop to continue using your old mouse or printer. Prices vary widely from store to store, and while one dongle might not seem expensive, a few can quickly run up your costs. Compare prices at major electronics retailers like Best Buy and Micro Center, which offer cords that start around \$10.



A FANCY DISPLAY

A 4K Ultra High Definition display looks great, but you don't need one unless you stream a lot of 4K movies or edit photos for a living. For standard Netflix fare, a traditional 1080p (Full HD) screen

will serve you just fine and consume far less battery power. It costs a whole lot less, too. In the case of Dell's 13-inch XPS laptop, the 4K display adds about \$300 to the price.

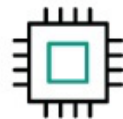

AN ALL-POWERFUL PROCESSOR

Yes, it's true that as you move from an Intel Core i3 to a Core i5, Core i7, and Core i9 the processing power increases. But you don't need an i7 for browsing the web. It's more appropriate for truly demanding tasks such as video editing or high-end gaming. If you go with the Intel Core i5—or AMD's Ryzen 5—it will handle everyday jobs with plenty of speed.



GAME-READY GRAPHICS CARDS

If you're a diehard gamer or a professional film editor, you might

spring for a graphics card (aka graphics processing unit) made by Nvidia or AMD. But if you haven't played a video game since the days of Frogger and Pac-Man, just say no thanks. You don't need a laptop made to zip through graphics and video data, especially when it adds \$100 or more to the overall cost.



SUPER-SIZED STORAGE

It's hard to envision how much space you need to stow all of your photos and videos, especially when media files have increased in size because of advances in resolution. But don't get suckered into paying for gigabytes you won't use. Antonette Asedillo, who oversees computer testing for CR, says that a 256GB solid-state drive should suffice for the average user, especially if you also store files in a cloud service. (If you want a lot more onboard storage, look at laptops with traditional hard drives, which routinely come with 1TB.)

Ratings **Lean Machines** These laptops, Chromebooks, and desktops navigated our rigorous tests, with many of them emerging as recommended models.

Brand + Model	Overall Score	Price	Survey Results		Test Results				Features					
			Predicted reliability	Owner satisfaction	Ergonomics	Portability	Performance	Display	Battery life, web (hr.)	Battery life, video (hr.)	Weight (lb.)	2-in-1	Display size (in.)	Processor
12- TO 13-INCH LAPTOPS														
✓ Apple MacBook Pro 13-inch With Touch Bar (2019, Core i5)	80	\$2,000	↑	↑	↑	↑	↑	↑	16	7.25	3		13.3	Intel Core i5
✓ LG Gram 13 8th Gen	79	\$1,120	↑	↓	↑	↑	↓	↑	16.25	11	2.1		13.3	Intel Core i5
✓ Apple MacBook Air 13-inch (2019, MVFH2LL/A)	73	\$1,100	↑	↑	↑	↑	↓	↑	11.5	7.5	2.7		13.3	Intel Core i5
✓ Apple MacBook Air 13-inch	72	\$900	↑	↑	↑	↑	↓	↑	10	7.25	2.7		13.3	Intel Core i5
✓ Microsoft Surface Pro 6 (Core i7)	70	\$1,335	↓	↑	↑	↑	↑	↑	11.25	7.75	2.4	D	12.3	Intel Core i7
✓ Microsoft Surface Laptop 2 (Core i7)	69	\$1,300	↓	↑	↑	↑	↓	↑	12.5	8	2.8		13.5	Intel Core i7
✓ Samsung Notebook 9 Pro (2019)	69	\$1,100	↑	↓	↑	↑	↑	↑	8.5	7.25	2.8	C	13.3	Intel Core i7
✓ Dell XPS 13 (XPS9380-7066SLV)	68	\$1,860	↓	↓	↑	↑	↑	↑	11.25	7	2.7		13	Intel Core i7
✓ HP Spectre Folio	68	\$1,400	↓	↓	↑	↑	↓	↑	18.5	10.25	3.2	C	13.3	Intel Core i7
✓ Microsoft Surface Pro 6 (Core i5)	68	\$800	↓	↑	↑	↑	↓	↑	10.75	7.5	2.4	D	12.3	Intel Core i5
✓ Asus ZenBook UX331UA-AS51	68	\$800	↓	↓	↑	↑	↓	↑	13.75	7.75	2.7		13.3	Intel Core i5
✓ Microsoft Surface Laptop (Core i7)	67	\$750	↓	↑	↑	↑	↓	↑	12.5	7.5	2.8		13.5	Intel Core i7
✓ Microsoft Surface Book 2	67	\$810	↓	↑	↑	↑	↓	↑	16	10.25	3.4	D	13.5	Intel Core i5
✓ Microsoft Surface Laptop 2 (Core i5)	65	\$1,000	↓	↑	↑	↑	↓	↑	12.75	8.25	2.8		13.5	Intel Core i5
Lenovo ThinkPad L380 Yoga	64	\$900	↓	↓	↑	↓	↓	↑	10.75	7.75	3.3	C	13.3	Intel Core i5
Samsung Notebook 7 Spin	63	\$720	↑	↓	↑	↓	↓	↑	9.5	6	3.2	C	13.3	Intel Core i5
14-INCH LAPTOPS														
✓ LG Gram 14 8th gen	76	\$1,350	↑	↓	↑	↑	↓	↑	15.25	11.25	2.2		14	Intel Core i7
✓ Asus ZenBook S UX392FN-XS71	70	\$1,380	↓	↓	↓	↑	↑	↑	14	8.75	2.6		13.9	Intel Core i7
✓ MSI Prestige PS42 Modern-074	70	\$1,200	↓	↓	↑	↑	↑	↑	8.75	6.75	2.8		14	Intel Core i7
✓ Huawei MateBook D Volta-W50D	68	\$900	—	—	↑	↑	↑	↑	14.75	9.5	3.4		14	Intel Core i5
✓ Acer Swift 5 SF514-52TP-52LH	67	\$945	↓	↓	↑	↑	↑	↑	9.25	5.25	2.1		14	Intel Core i7
✓ Asus ZenBook Flip UX461UA-DS51T	67	\$980	↓	↓	↑	↑	↓	↑	11	7	3.3	C	14	Intel Core i5
✓ Lenovo Flex 6-14IKB	65	\$900	↓	↓	↑	↑	↓	↑	12	7	3.4	C	14	Intel Core i5
15- TO 16-INCH LAPTOPS														
✓ Apple MacBook Pro 15-inch With Touch Bar (2019, Core i7)	82	\$2,400	↑	↑	↑	↑	↑	↑	15.5	7	4		15.4	Intel Core i7
✓ Samsung Notebook 9 Pen (2019)	81	\$1,770	↑	↓	↑	↑	↑	↑	11.25	7.75	3.4	C	15	Intel Core i7
✓ HP Spectre 15-DF0023DX x360	80	\$1,600	↓	↓	↑	↑	↑	↑	16.5	8.5	4.6	C	15.6	Intel Core i7

Brand + Model	Overall Score	Price	Survey Results		Test Results				Features				
			Predicted reliability	Owner satisfaction	Ergonomics	Portability	Performance	Display	Battery life, web (hr.)	Battery life, video (hr.)	Weight (lb.)	2-in-1	Display size (in.)

15- TO 16-INCH LAPTOPS *Continued*

✓ LG Gram 15	76	\$1,530	↑	↑	↑	↑	↓	↑	13.5	11	2.5		15.6	Intel Core i7
✓ MSI GS65 Stealth-006	74	\$1,700	↓	↓	↑	↓	↑	↑	7.5	6	4.4		15.6	Intel Core i7
✓ Dell XPS 15 8th gen	73	\$1,600	↓	↓	↑	↑	↑	↑	9.25	5.25	4.4	C	15.6	Intel Core i7
✓ Asus Q526FA-BI7T10	72	\$1,050	↓	↓	↑	↑	↑	↑	10.75	7.5	4.3	C	15.6	Intel Core i7
💰 Lenovo Flex 15	72	\$750	↓	↓	↑	↑	↑	↑	12.25	8.25	4.7	C	15.6	Intel Core i7
✓ Lenovo Yoga 730-13IKB	69	\$745	↓	↓	↑	↑	↑	↑	9.75	7	4.2	C	15.6	Intel Core i7
✓ Dell Inspiron i7586-7205BLK	69	\$1,170	↓	↓	↑	↓	↑	↑	8.25	5.5	4.5	C	15.6	Intel Core i7
✓ HP Envy 15M-DR0011DX x360	68	\$850	↓	↓	↑	↑	↑	↑	11	7.25	4.2	C	15.6	Intel Core i5
✓ Razer Blade 15	68	\$1,800	–	–	↓	↓	↑	↑	7	5.75	4.5		15.6	Intel Core i7
✓ Acer Predator Helios 300	68	\$1,000	↓	↓	↑	↓	↑	↑	6.75	3.25	5.7		15.6	Intel Core i7
✓ HP Pavilion Gaming 15-CX0058WM	67	\$830	↓	↓	↑	↓	↑	↑	8.25	4.5	5.2		15.6	Intel Core i5
✓ HP Envy 15M-DS0011DX x360	67	\$780	↓	↓	↑	↑	↑	↑	10	6.25	4.4	C	15.6	AMD Ryzen 5
✓ Dell G5 15	66	\$800	↓	↓	↓	↓	↑	↑	9	5.5	6.2		15.6	Intel Core i7
✓ HP Pavilion 15-CS1063CL	65	\$500	↓	↓	↑	↑	↑	↓	9.75	6.5	4		15.6	Intel Core i5
✓ Dell G3 15	65	\$850	↓	↓	↑	↓	↑	↑	8	4.75	5.3		15.6	Intel Core i5
Alienware 15 R4	64	\$1,500	↓	↑	↑	↓	↑	↑	7	3.75	7.8		15.6	Intel Core i7
Acer Aspire 5 A515-52-53QM	64	\$700	↓	↓	↑	↑	↑	↓	9.5	7.25	3.7		15.6	Intel Core i5
Dell G7 15	63	\$1,080	↓	↓	↓	↓	↑	↑	7.25	5	5.9		15.6	Intel Core i7
HP 15-DA1005DX	63	\$710	↓	↓	↑	↑	↑	↓	8	7	4.2		15.6	Intel Core i7
Lenovo IdeaPad S145-15IWL	63	\$730	↓	↓	↑	↑	↑	↓	8.25	6.25	3.7		15.6	Intel Core i7

CHROMEBOOKS

✓ Asus Chromebook Flip C434TA-DSM4T	84	\$550	↑	↑	↑	↑	↑	↑	12.25	6.5	3.1	C	14	Intel Core m3
✓ Acer Chromebook CB713-1W-36XR	82	\$700	↑	↑	↑	↑	↑	↑	11.25	6.5	3		13.5	Intel Core i3
✓ Google Pixelbook	81	\$1,000	↑	↑	↑	↑	↑	↑	10	5	2.5	C	12.3	Intel Core i5
✓ HP Chromebook 14-DA0011DX x360	79	\$500	↑	↓	↑	↑	↑	↓	12.75	8.25	3.5	C	14	Intel Core i3
✓ HP Chromebook 15-DE0035CL	78	\$550	↑	↓	↑	↑	↑	↑	12.5	7.5	4		15.6	Intel Core i3
💰 Asus Chromebook Flip C214MA-YS02TS	78	\$350	↑	↑	↑	↑	↓	↑	14.5	6.5	2.7	C	11.6	Intel Celeron
✓ HP X2 12-F014DX	78	\$450	↑	↓	↑	↑	↑	↑	12.75	7	3.2	D	12.3	Intel Core m3

Brand + Model	Overall Score	Price	Survey Results		Test Results				Features				
			Predicted reliability	Owner satisfaction	Ergonomics	Portability	Performance	Display	Battery life, web (hr.)	Battery life, video (hr.)	Weight (lb.)	2-in-1	Display size (in.)

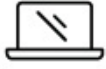

CHROMEBOOKS *Continued*

✓ Asus Chromebook Flip C302CA-DHM4	77	\$480	↑	↑	↑	↑	↑	↑	9.75	4.75	2.5	C	12.5	Intel Core m3
✓ Acer Chromebook C732-C6WU	73	\$290	↑	↑	↑	↑	↓	↓	17.25	7.5	2.8		11.6	Intel Celeron
✓ Dell Inspiron Chromebook C7486-3250GRY	72	\$400	↓	↓	↑	↑	↑	↑	12	7.25	4	C	14	Intel Core i3
✓ Acer Chromebook CB315-2H-25TX	71	\$300	↑	↑	↑	↑	↓	↓	12.75	6.25	4		15.6	AMD A4
Ⓢ Acer Chromebook CB3-431-12K1	70	\$230	↑	↑	↑	↑	↓	↓	11.5	6.75	3.3		14	Intel Atom X5
✓ Asus Chromebook C223NA-DH02	70	\$230	↑	↑	↑	↑	↓	↓	10	5.25	2.2		11.6	Intel Celeron
Asus Chromebook C423NA-WB04	69	\$270	↑	↑	↑	↑	↓	↓	8.75	4.75	2.7		14	Intel Celeron
HP Chromebook 14-DB0061CL	68	\$300	↑	↓	↑	↑	↓	↓	12.5	5.25	3.4		14	AMD A4
Samsung Chromebook Plus V2	68	\$520	↑	↓	↑	↓	↓	↑	7.25	5.25	2.9	C	12.2	Intel Celeron
HP Chromebook 14-CA061DX	68	\$210	↑	↓	↑	↑	↓	↓	11.5	6.5	3.3		14	Intel Celeron

Brand + Model	Overall Score	Price	Survey Results		Test Results				Features	
			Predicted reliability	Owner satisfaction	Ergonomics	Performance	Versatility	Display	Display size (in.)	Processor



ALL-IN-ONE DESKTOPS

✓ Apple 27-inch iMac 5K Display (2019, MRQY2LL/A)	88	\$1,800	↑	↑	↑	↑	↑	↑	↑	27	Intel Core i5
✓ Apple 21.5-inch iMac With 4K Display MNDY2LL/A	86	\$1,500	↑	↑	↑	↑	↑	↓	↑	21.5	Intel Core i5
✓ Apple 21.5-inch iMac MMQA2LL/A	83	\$1,100	↑	↑	↑	↑	↓	↑	↑	21.5	Intel Core i5
✓ Asus Zen AiO ZN242GDT-08	79	\$1,100	↓	↓	↑	↑	↑	↑	↑	23.8	Intel Core i7
Ⓢ Lenovo ideacentre 520-24ARR	75	\$550	↓	↓	↑	↓	↑	↑	↑	23.8	AMD Ryzen 3

> All-Access and Digital members can find the latest, complete ratings at [CR.org/laptops](https://www.crdigital.com/laptops).

HOW WE TEST: Overall Score combines test results with survey data for predicted reliability and owner satisfaction. Predicted reliability estimates the likelihood that newly purchased models from a given brand will break or experience problems within the first three years. Owner satisfaction reflects the proportion

of CR members who are extremely likely to recommend the computer they bought. In cases where we have insufficient survey data to provide a brand-level rating, indicated by a gray dash (-), we assume the model has average reliability and satisfaction. The Ergonomics score evaluates the quality of the keyboard, pointing

device, and accessibility features. Portability is based on battery life, size, and weight, including the keyboard dock for detachable laptops. For Performance we evaluate how well the model operates while running apps and 3D games, and browsing the web. Versatility assesses technical support, warranty provisions, and

useful hardware features such as memory card slots and audio/video connections. The Display score looks at size, color, brightness, and glare. The 2-in-1 column marks models with a "C" for convertibles and a "D" to signify detachables.

Shop Smarter for Supplements



Turmeric ... echinacea ... ginger ... beetroot. Plant-derived supplements (known as botanicals) make many health enhancement claims, and yet the market is largely unregulated. If you're currently taking these, or considering taking them, our testing and expert advice will help you shop wisely—and more safely.

BY KEVIN LORIA • PHOTOGRAPHS BY NIGEL COX



CLOCKWISE
FROM TOP LEFT

GREEN TEA

BEETROOT

CHAMOMILE

GINGER

ECHINACEA

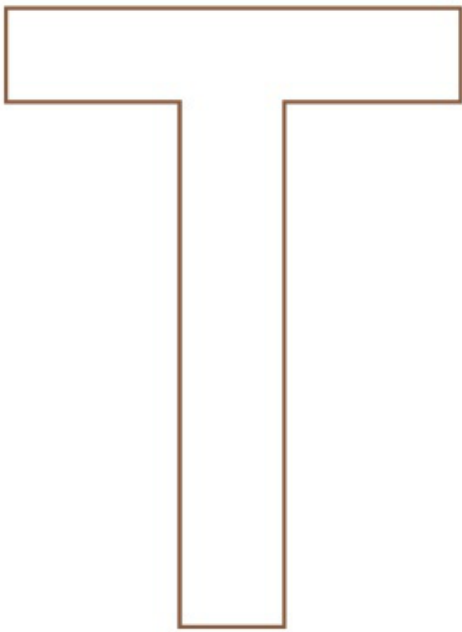

THE PROMISE OF SUPPLEMENTS is pretty powerful: That they'll ease your pain, boost your immunity, settle your stomach, strengthen your heart, sharpen your memory, and more. Little wonder, then, that supplement sales in the U.S. reached \$46 billion in 2018 and are predicted to exceed \$52 billion by 2020. In fact, 68 percent of Americans take supplements at least once a week, according to a recent nationally representative Consumer Reports survey of 2,006 adults.

So it's perhaps remarkable that there's not, to date, a lot of solid evidence that supplements do what people hope they will. Manufacturers are not required to demonstrate to the government that their products are effective or safe before they are sold—as they must with prescription and over-the-counter drugs, such as Advil. People have long used botanicals like echinacea to help with infections such as the common cold, and turmeric to curb inflammation and pain. But both—despite showing promising results in lab settings—fail to provide significant benefits over a placebo in most structured clinical trials. For example, an August 2019 review looked at 19 clinical trials of turmeric and its active compound, curcumin, to see whether either could reduce inflammation in patients with chronic inflammatory diseases, such as osteoarthritis. It found no sign that either had a significant effect. "There are simply not good studies that support a lot of supplement claims," says Robert McLean, M.D., a rheumatologist at Yale New Haven Hospital and president of the American College of Physicians.

Among the most widely used supplements in our survey are multivitamins and vitamins, followed by fish oil, calcium, and probiotics. But the market for botanicals—a category of supplements derived from plants—has grown from about \$4.2 billion in 2000 to more than \$8.8 billion in 2018, according to Nutrition Business Journal. Our survey found that among people who had taken supplements in the previous year, 38 percent had taken at least one botanical.

One reason supplement sales may remain stubbornly robust is because "there's a strong placebo effect," McLean says. "People will feel better if they think they're going to feel better."

That means consumers are often left guessing about efficacy. Suyash Raj, a research technician, concedes "it's very hard to quantify" the exact effect of the two botanical supplements he takes. But he has looked at studies to research their safety, and says they seem to help him with stress. "I feel better," he says—adding that "of course that could be a placebo [effect]." Similarly, Stacy Bond, a writer and public radio producer, now takes multiple supplements to help deal with a few health concerns. While she says she's not sure they're all effective, "there's something, I think, maybe before I was lacking that I'm now getting from the supplements."

Also muddying the evidentiary waters: Research shows that people who buy supplements tend to be healthier than the average person in the first place.

CR's survey also found that 48 percent of Americans believe supplements have been tested for safety by the Food and Drug Administration, even though the agency does not do comprehensive testing of them. Another 71 percent believe supplements are safe. But many pose dangers, says Pieter Cohen, M.D., an internist at Harvard Medical School who has studied supplements extensively. One 2015 study by government researchers

Who Takes Supplements and Why?

People of all ages take supplements, but older Americans are most likely to take multiple types.*

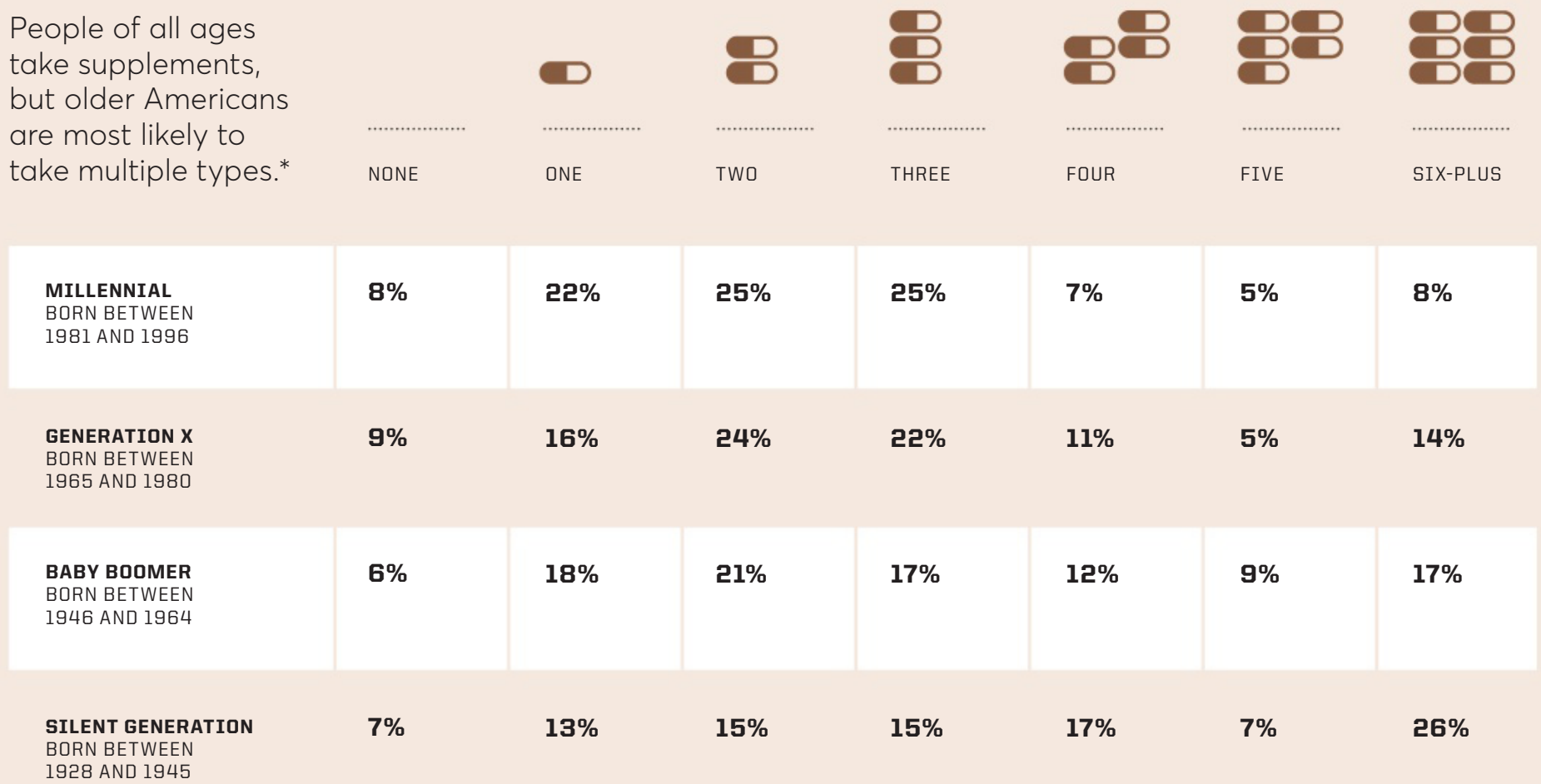

*Number of different supplements taken in the past year among people who have ever taken supplements.

How often, and for how long, have Americans taken supplements?

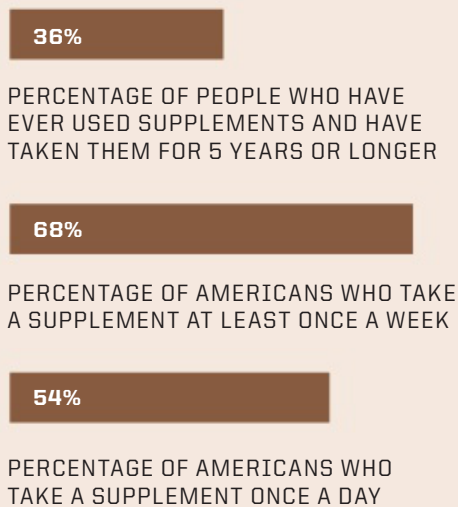

Americans place a lot of trust in the safety of supplements even though they are largely unregulated.

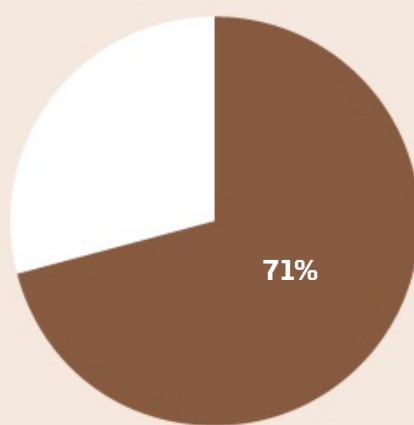

PERCENTAGE OF AMERICANS WHO SAY SUPPLEMENTS ARE SAFE**

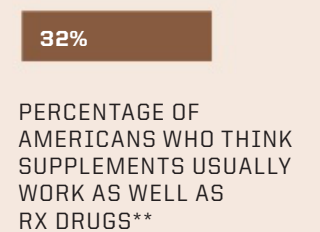
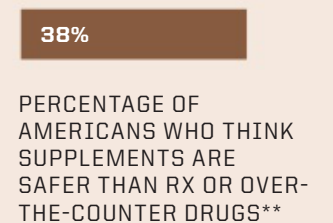
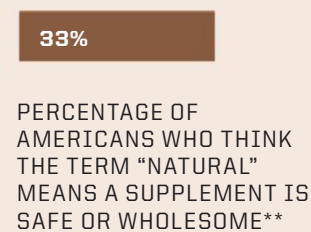
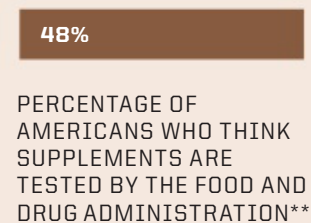

**Percentage of people who said the statements were true or mostly true.
Source: Consumer Reports nationally representative survey of 2,006 adults.

found that supplement use led to more than 23,000 emergency room visits a year, most often because of heart problems triggered by supplements taken for weight loss and energy.

“There’s a lack of oversight, a lack of safety, and a lack of rigorous science,” says Daniel Lasoff, M.D., a medical toxicologist at the University of California, San Diego’s department of emergency medicine.

CR tested turmeric and echinacea, and our findings revealed problems with potency and purity even among some of the most widely used brands. (See “CR Tests: Turmeric and Echinacea,” on page 36.)

And yet “dietary supplements have benefits to offer,” says Richard van Breemen, Ph.D., a professor of pharmaceutical sciences and the director of the Linus Pauling Institute at Oregon State University, which focuses on vitamin, mineral, and plant-derived chemical research. He cites black cohosh (see “A Guide

to 10 Popular Botanicals,” on page 32) as one example where some women say it eases their menopausal symptoms, even though scientists don’t understand how it works. But before supplements can be used effectively to address specific ailments, “we need more research on botanicals to figure out the optimum preparations and dosages,” he says, adding that more information is also needed on their long-term safety.

THE POTENCY OF PLANTS

The top reasons for taking botanicals, aside from turmeric and echinacea (see “Lifestyle Changes That Work—Without the Risks,” on page 35), were “to improve or maintain overall health” and “to strengthen general immunity,” according to our survey.

Plants have, in fact, been used for medicinal purposes for thousands of years. Today, approximately half of prescription medicines in use are

derived from plants, microbes, and fungi found in the natural world, according to van Breemen at Oregon State. But the key difference is that prescription drugs used to treat cancer and other diseases are standardized, with each dose containing the exact same quantity of active ingredients.

Such standardization is not mandatory for supplements in the U.S. This is partly why figuring out which botanicals are safe and effective—and which may be useless or risky—can be particularly challenging. Botanicals include turmeric, St. John’s wort, green tea extract, and valerian. (CBD, or cannabidiol, is botanical in origin, which is why many people think of it as a botanical supplement. But the FDA currently considers it illegal to sell the trendy compound from the cannabis plant as a supplement because it’s approved as a drug to treat rare forms of epilepsy. See more at [CR.org/cbd](https://www.consumerreports.org/cbd).)

Part of the challenge is that plant-derived pills can be extremely potent—and that potency can be dangerous. According to Harvard’s Cohen, some botanicals—red yeast rice, used for heart problems, and the now-banned ephedra, once found in weight-loss supplements—can deliver the same amount of a “natural” chemical as a prescription drug. That means that they can have side effects that are similar to (though less predictable than) those of drugs, according to Cynthia Rider, Ph.D., a toxicologist at the National Toxicology Program at the National Institute of Environmental Health Sciences (NIEHS).

Take, for example, vinpocetine, a synthetic substance derived from a chemical found in the *Vinca minor* plant. In some countries it’s sold as a prescription drug to treat stroke or cognitive impairment. However, in the U.S. it isn’t an FDA-approved prescription drug but is sold as a botanical ingredient in some memory

[CONT. ON PAGE 34]

WHAT THE FDA DOES—AND DOESN’T—DO

Even though some supplements are as potent as certain prescription drugs, different regulations apply. The Food and Drug Administration doesn’t need to approve supplements as effective or safe before they are sold, as it does with drugs.

According to the Dietary Supplement Health and Education Act of 1994—the primary law that governs these products—supplement ingredients that were on the market before 1994 are presumed safe. Companies can assert that a product is safe for use as long as they can provide some evidence that its ingredients were used before 1994 or are currently present in the

food supply. While manufacturers are supposed to notify the FDA when they start selling a supplement that contains a new ingredient, they often don’t, according to Chuck Bell, in the advocacy division of CR.

The FDA technically requires that supplements contain what they say they do and aren’t contaminated with harmful substances. But supplements have exploded in popularity since 1994. Current regulations can’t keep consumers safe, Bell says. “We’re dealing with a much larger industry, and the number of people that are employed by the FDA to oversee that industry has not kept pace,” he says.

How to Choose Products Wisely

If you're shopping for supplements in a store, don't expect much help from the pharmacist or other staffers. That's the conclusion we drew after sending 10 secret shoppers to ask about echinacea and turmeric in 34 stores (branches of Costco, CVS, GNC, Kroger, Target, The Vitamin Shoppe, Walgreens, and Walmart) in seven states. In most cases, pharmacists weren't familiar with potential risks for the supplements on their shelves and rarely warned customers about problems such as interactions with prescription medications. A notable few did; when one saw the list of Rx medications our shopper was taking, he wisely advised her not to take any supplements without consulting her physician.

Because the Food and Drug Administration doesn't verify that supplements contain what they say they do or whether they are contaminated with heavy metals, bacteria, or pesticides before they are sold, some third-party groups have taken on the role.

These groups (see chart at right) include ConsumerLab.com, NSF International, and U.S. Pharmacopeia (USP). USP is a nonprofit organization that sets what CR experts say are the most widely accepted standards for supplements. (It also sets mandatory standards for pharmaceuticals.) The not-for-profit NSF offers two types of certification: NSF Contents Certified and NSF Certified for Sport. ConsumerLab.com, a for-profit company, regularly tests and certifies

supplements. A more recent addition is UL, a for-profit company known for testing electronics. Some of these organizations, such as USP (quality-supplements.org) and NSF (info.nsf.org/certified/dietary), list verified or certified products on their websites.

Even if a supplement has been certified to show that it

contains what's on its label, it could still cause serious side effects, according to Pieter Cohen, M.D., an internist at Harvard Medical School who has worked closely with NSF.

In May, CVS announced that it had completed an initiative to make sure every supplement it sells has been through third-party testing. Seven percent

of products didn't pass the screening, a CVS spokesperson says, mostly because of failures to meet label claims. (The CVS products in CR's tests were sold before CVS had fully implemented its new initiative.)

Many other stamps you'll see on bottles ("verified" or "approved") are meaningless, Cohen says.

	 CONSUMER LAB.COM	 NSF INTERNATIONAL	 UL	 U.S. PHARMACOPEIA
How does it acquire test samples?	Purchased when a manufacturer requests testing.	Provided by the manufacturer.	Manufacturer-provided or selected by UL at manufacturing location.	Provided by the manufacturer.
How often does it retest or spot-check?	Once every 12 to 24 months, using samples from stores.	Once per year, using samples provided by manufacturer (occasionally purchased in stores).	At least once per year.	One to six times per year, using samples purchased in stores.
How much does it charge to have products certified or ingredients verified?	\$3,000 to \$5,000 per product.	\$3,000 to \$5,000 per product, plus an audit fee of about \$13,000.	\$300 to \$3,500 for active-ingredient testing.	Varies. Depending on ingredients, can be \$3,000 to \$15,000 per product, plus an initial audit fee of \$15,000 and a label fee of 1 cent per bottle.
Are there products it won't test?	Products containing ingredients known to be unsafe.	Sex enhancement or weight loss products and those with ingredients known to be illegal or unsafe, not recognized by the FDA, or that there's no test for.	Products containing ingredients known to be unsafe, illegal, or not recognized as dietary ingredients by the FDA.	Products that contain ingredients known to be unsafe, that aren't recognized as dietary ingredients by the FDA, or that there's no validated test for.

A Guide to 10 Popular Botanicals

All these supplement ingredients are derived from plants. But they vary in efficacy and safety. For a partial list of supplement ingredients to outright avoid, see [CR.org/ingredientstoavoid](https://www.consumerreports.org/ingredientstoavoid).



CLOCKWISE
FROM TOP

GREEN TEA

BLACK COHOSH

CRANBERRY

GINGER

BEETROOT

Beetroot

Reasons for Use

Generally sold as a powder that can be mixed into a juice, to improve athletic performance.

How Well It Works

Though research has yielded conflicting results, studies suggest it might improve performance in endurance sports, such as running, swimming, rowing, and cycling.

Known Risks

More research is needed, but there have not been major safety concerns identified with moderate consumption (2 cups a day) for several weeks, as is commonly recommended.

Black Cohosh

Reasons for Use

To treat menopausal symptoms and sometimes menstrual cramps, or to induce labor.

How Well It Works

Knowledge is limited, with insufficient evidence to support use.

Known Risks

While black cohosh itself has been shown to be generally safe when taken for as long as a year, many black cohosh products have been found to contain unlisted herbs mixed in. Cases of liver damage have also been linked to black cohosh, potentially because of the other herbs.

Chamomile

Reasons for Use

For sleeplessness, anxiety, and gastrointestinal conditions.

How Well It Works

It's not well-studied, though preliminary research indicates that it may be helpful for anxiety and may ease an upset stomach if taken in combination with other herbs, including milk thistle and peppermint.

Known Risks

As a tea, it's generally considered safe. Some people allergic to plants such as ragweed may have a reaction to chamomile. It can also interact with drugs used after organ transplants as well as with some blood thinners.

Cranberry

Reasons for Use

Mostly used to treat urinary tract infections (UTIs).

How Well It Works

Evidence is mixed. Some studies indicate that cranberry may reduce UTI risk for certain people, but research hasn't shown that it works as a UTI treatment.

Known Risks

Drinking cranberry juice is generally safe, though it's usually high in sugar. Large quantities can lead to upset stomach, and drinking a lot of cranberry juice on a regular basis can increase the risk of kidney stones. Cranberry supplements may interact with blood-thinning drugs.

Ginger

Reasons for Use

Commonly used to treat nausea and vomiting and sometimes for other conditions, including arthritis and motion sickness.

How Well It Works

Ginger may help with nausea related to pregnancy and chemotherapy, studies have shown. Evidence is less certain on whether it can ease other types of nausea or conditions.

Known Risks

Usually considered safe when used as a spice. Some users may experience gas and heartburn; it may also be problematic for people with gallstones. And it can interact with blood-thinning meds.

Green Tea Extract

Reasons for Use

Mainly to improve alertness, relieve digestive symptoms, and promote weight loss.

How Well It Works

Green tea seems to make people more alert, probably because of the caffeine. There's not good evidence that it helps people lose weight.

Known Risks

Drinking green tea in moderate amounts is believed to be safe. But green tea extract has been linked to serious problems, including liver damage, elevated blood pressure, increased heart rate, and even death. CR recommends avoiding green tea extract supplements.

Milk Thistle

Reasons for Use

Mostly used for liver problems related to conditions such as hepatitis and cirrhosis.

How Well It Works

Results have been uneven. Some research shows certain patients who take milk thistle have milder symptoms from liver disease; other studies have found it's no better than a placebo.

Known Risks

Well-tolerated in recommended doses, though some report gastrointestinal problems. Can trigger allergic reactions, especially for people also allergic to ragweed. Diabetics should also use caution with milk thistle because it may lower blood sugar levels.

Saw Palmetto

Reasons for Use

To treat the symptoms of an enlarged prostate—an age-related condition in men that can make urination difficult.

How Well It Works

Small studies suggested a possible benefit, but the best well-designed large studies have concluded that it's no more effective than a placebo.

Known Risks

There are few known side effects, though some people experience mild ones, such as headaches.

St. John's Wort

Reasons for Use

Primarily for depression; sometimes to treat menopause symptoms, attention deficit hyperactivity disorder, and obsessive-compulsive disorder.

How Well It Works

It seemed to ease depression in a few studies, but results are mixed. Evidence indicates it is not helpful for ADHD or other conditions.

Known Risks

It can interact in life-threatening ways with certain drugs and has been shown to weaken antidepressants, birth control pills, some cancer drugs, and warfarin. It has also been linked to side effects such as anxiety, fatigue, and sexual dysfunction.

Valerian

Reasons for Use

Mainly used to treat insomnia, though some also use it to treat anxiety, depression, or menopause symptoms.

How Well It Works

It's unclear how much valerian helps with sleep because there's not much rigorous research on the topic and results of existing studies have varied. There's too little evidence to know whether it can help with other conditions.

Known Risks

Some people experience mild side effects, such as headaches and itching. There are not major safety concerns with short-term use in adults; the effects of long-term use are unknown.

[CONT. FROM PAGE 30]

supplements. Vinpocetine can cause dangerously low blood pressure, and birth defects or miscarriage if taken by a pregnant woman.

The form and source of raw ingredients also vary: Research indicates that some overseas suppliers of turmeric spice have sometimes intentionally added lead to it to brighten its distinctive color, making it especially risky when consumed regularly. The same plant grown in California and India can have different levels of active compounds. Additionally, many plants can suck up heavy metals from the soil as they grow, turning a safe plant dangerous. And botanical supplements are sometimes manufactured in unsanitary conditions, allowing bacteria to be introduced into the products.

One particularly harmful side effect linked to supplements is liver damage. In 2004, the percentage of all liver damage cases in the U.S. involving herbal or dietary supplements was estimated at 7 percent; by 2014, that number was estimated to have climbed to 20 percent, mostly because of green tea extract in weight loss supplements, and steroids illegally added to bodybuilding supplements.

Active compounds in supplements can also amplify the effects of prescription drugs or render other medications ineffective. Ginkgo biloba, for example, can thin the blood, increasing the effect of a prescription blood thinner, such as warfarin.

“I have totally seen this perception of ‘natural’ equals safe,” says Rider at the NIEHS. “I think it is not a fair assumption.”

The results of CR’s tests of echinacea and turmeric conform with the kinds of problems also seen by Tod Cooperman, M.D., the president and founder of ConsumerLab.com, an organization that regularly tests supplements and certifies products that pass its quality control tests.

Representatives of the supplement industry point to products with major problems or inconsistencies as outliers. “There are some supplements in the marketplace that either don’t contain what their label says they are supposed to contain or they contain things that are not supposed to be there, but that is a very small minority of the industry,” says Steve Mister, president and CEO of the Council for Responsible Nutrition, a dietary supplements trade organization.

Yet according to Cooperman, more than 25 percent of the botanical supplements that ConsumerLab.com examines fail the organization’s testing, either because of bacterial or heavy metal contamination or because they don’t contain what’s listed on the label. Botanical supplements are much more likely to fail these tests than mineral or vitamin supplements because, he says, plants often have different levels of active compounds and can pick up contamination from the environment where they were grown or packaged.

MORE THAN

80,000

SUPPLEMENT

PRODUCTS MAY BE

ON THE MARKET

RIGHT NOW,

AND THE NUMBER

CONTINUES

TO GROW.

PROTECTIONS ON THE WAY?

The FDA doesn’t test supplements for safety or screen them for contaminants before they are sold, but it does require that supplements contain the ingredients listed on their labels. However, the agency doesn’t perform comprehensive tests to verify compliance. And although complying with U.S. Pharmacopeia (USP) quality standards—including tests for identity, potency, and purity—is mandatory for prescription and over-the-counter drugs, doing so is voluntary for supplements. Most manufacturers do not opt in—especially when it comes to botanicals, where standardization can be a challenge, proprietary blends are common, and there is less agreement about appropriate dosage.

The FDA generally recalls a supplement if it receives a large number of reports (from consumers, doctors, manufacturers, and others) indicating that it might be causing serious illnesses—because of contamination with salmonella or prescription-drug ingredients, for example. The agency has issued 34 recalls for dietary supplements over the past two years, according to an FDA database. But a product that simply doesn’t contain what it should could potentially fly under the radar indefinitely, Harvard’s Cohen says.

Earlier this year, the FDA indicated that it would be taking steps to more strictly regulate the supplement marketplace, and launched a new online list to warn consumers about certain supplement ingredients. An FDA spokesperson also told CR that the agency has continued to step up enforcement against bad actors. It cited, among other examples, the recent seizure of 300,000 containers of dietary supplements manufactured in substandard conditions, and recalls of drugs illegally sold as supplements.

Even though these increased

WHAT IS AVAXHOME?

AVAXHOME-

the biggest Internet portal,
providing you various content:
brand new books, trending movies,
fresh magazines, hot games,
recent software, latest music releases.

Unlimited satisfaction one low price

Cheap constant access to piping hot media

Protect your downloadings from Big brother

Safer, than torrent-trackers

18 years of seamless operation and our users' satisfaction

All languages

Brand new content

One site



AVXLIVE **ICU**

AvaxHome - Your End Place

We have everything for all of your needs. Just open <https://avxlive.icu>

Lifestyle Changes That Work—Without the Risks

efforts to enforce the law are a positive step, consumers have a right to expect the FDA to have been doing this all along, says Chuck Bell, who has led CR's advocacy work on supplements for 20 years. Nor does it change the fact that—over several decades—the agency has been slow to push for changes to regulations that experts say continue to leave too many unsafe products on the market. “Progress has been glacial,” Bell says.

WHAT CONSUMERS CAN DO

When it comes to safety, the onus still largely falls on consumers to be advocates for themselves. Indeed, industry representatives say consumers should do their own research to find safe products. “You have some responsibility to become informed about the supplements you use,” says Michael McGuffin, president of the American Herbal Products Association, an industry group. “We recommend consumers consult with their healthcare practitioner.”

Before you try any supplement, Bell says, you should discuss it with your primary care provider and seek out trustworthy information from sources such as MedlinePlus.gov, the NIH's health portal for consumers.

A frank assessment of your own habits is probably in order, too. As much as supplement-takers might believe that supplements are safe and effective, many mainstream healthcare practitioners say the products are a waste of money. For those committed to continuing supplement use, see “How to Choose Products Wisely,” on page 31, to help you spot labels that can identify more trustworthy products.

“One day I envision that this industry will have products that are shown to be both safe and effective,” says van Breemen at Oregon State. “But we're not there yet.”

People often take echinacea to bolster immunity and ward off colds or other viruses. They turn to turmeric to alleviate pain or to reduce inflammation due to psoriasis or rheumatoid arthritis. In our survey, turmeric was the most popular supplement for chronic health problems.

Some studies suggest that taking echinacea might make you slightly less susceptible to colds, and preliminary research indicates that curcumin could potentially help with knee pain from osteoarthritis. But conclusive evidence that these products work is lacking, according to experts who have studied them and the National Center for Complementary and Integrative Health at the National Institutes of Health.

There are, however, other, proven nonpharmacological ways you can get these desired health benefits.

STRENGTHEN YOUR IMMUNE SYSTEM

☐ **Get between 7 and 9 hours of sleep nightly.** This will improve your ability to fight off viral infections such as the common cold, says Robert McLean, M.D., a rheumatologist at Yale New Haven Hospital and president of the American College of Physicians.

☐ **Increase your intake of nutrient-dense foods.** These include fatty fish (sardines and salmon),

which provide vitamin D, key for immune-system function, says Julie Stefanski, a registered dietitian nutritionist and spokesperson for the Academy of Nutrition and Dietetics.

☐ **Rehab your diet with superfoods.** These include dark leafy greens, raspberries and blackberries, and citrus and broccoli, all good sources of vitamin C, which supports the immune system and healing. Pumpkin and sweet potatoes provide vitamin A for a strong immune system. And foods such as olive oil, chia seeds, and avocado provide vital nutrients that help to fight infection.

REDUCE INFLAMMATION

If you're dealing with inflammation from an injury, ice can reduce pain and swelling. For minor pains, an over-the-counter nonsteroidal anti-inflammatory drug, such as ibuprofen, can also provide short-term relief, McLean says.

You'll also want to avoid soda, processed meat, and too much alcohol (more than one drink a day for women or two drinks a day for men). Regular exercise and adequate sleep have also been shown to help with chronic inflammation. If you think you might have a medical condition, such as celiac disease, where certain foods trigger inflammation, talk to your doctor.

CR Tests: Turmeric and Echinacea



TO BETTER UNDERSTAND what's inside botanical supplements, Consumer Reports decided to put samples of two widely used ones to the test to determine their potency and purity: turmeric (sometimes referred to or sold as curcumin, which is one of its active compounds) and echinacea. In 2018, echinacea and turmeric were listed as the second and third most popular botanical supplements (after horehound, an ingredient in Ricola cough drops) in the annual market report from the American

Botanical Council, a nonprofit group that supports herbal medicine. (Echinacea is sold on its own, and it's also an ingredient in Airborne, an herbal blend that is claimed to fight colds.) Between 2017 and 2018, sales of turmeric grew 30.5 percent.

Of the 16 echinacea and 13 turmeric products we tested, we identified concerns with more than a third of them, including elevated levels of lead and bacteria, as well as low levels of key active compounds. (We

tested only pills, not gummies, powders, or teas.) Given the lack of regulation surrounding dietary supplements, companies can use a wide variety of standards—including their own. CR's scientists selected the testing methods and thresholds used in our evaluations based on their expert judgment. Our results are meant to help consumers compare their options and are not indicators of a product's compliance with any given standard.

Here's what we found.

Lead

None of the products we tested exceeded the lead standards set by U.S. Pharmacopeia (USP), a nonprofit group (see “How to Choose Products Wisely,” on page 31). But seven had lead levels that exceeded CR’s stricter threshold. “No amount of lead is acceptable,” says James E. Rogers, Ph.D., director of food safety research and testing at CR.

A spokesperson for Dollar General said the company stopped selling its affected product (see below) in targeted areas while it analyzed CR’s test results. A spokesperson for CVS said the company “commissioned an independent third-party expert [to confirm] that these products meet or exceed all legal and regulatory requirements.”

The other products with lead levels that exceeded CR’s threshold are all sold by Nature’s Bounty companies. “Any lead present is in amounts that are safe,” says Ashley Dickerson, a Nature’s Bounty spokesperson. What’s more, Dickerson says, “most of the lead in the product is naturally occurring.” However, CR’s Rogers says, “other products we tested were able to keep lead levels under our threshold, so saying it is natural is not an excuse.”

AFFECTED PRODUCTS

CVS HEALTH TURMERIC CURCUMIN
CVS HEALTH ECHINACEA
FINEST NUTRITION (WALGREENS) ECHINACEA
NATURE’S BOUNTY ECHINACEA, WHOLE HERB
PURITAN’S PRIDE PREMIUM ECHINACEA
REXALL (DOLLAR GENERAL)
WHOLE HERB ECHINACEA
SUNDOWN NATURALS
WHOLE HERB ECHINACEA

Bacteria

While none of the products we tested contained *E. coli* or salmonella, some significantly exceeded the USP standards for aerobic bacteria. Higher aerobic bacteria levels don’t

necessarily make a supplement unsafe to take, but they can indicate that products were manufactured or processed in unsanitary conditions.

The products listed here exceed the USP threshold for aerobic bacteria. But a Nature’s Way representative said these numbers are acceptable under guidelines from the American Herbal Products Association, an industry group. Organic India said the company had been having problems with counterfeiting and could not confirm to CR that the products we tested were theirs.

Michael McGuffin, president of the AHPA, said the USP standard “is not the only way you can assure a product is good.” But the fact that supplement companies can choose among many standards—or no standard—highlights why it’s so difficult for consumers to know what they’re getting, says Tunde Akinleye, a chemist in Consumer Reports’ food safety division who led our testing.

AFFECTED PRODUCTS

NATURE’S WAY ECHINACEA PURPUREA HERB
ORGANIC INDIA TURMERIC FORMULA

Key Active Compounds

For echinacea, the important chemicals are known as phenols; in turmeric, they are called curcuminoids.

One of the echinacea products we tested contained less than 20 percent of the phenol count listed on its label. And two other echinacea products didn’t contain any detectable amount of a key phenol associated with the echinacea species listed on the label. This could mean that the listed species wasn’t present or that low-quality echinacea was used, says CR’s Akinleye.

CR reached out to all three companies whose products were affected. Mason told CR that the company was “not making any claims to any standardized extract.” A spokesperson from GNC said, “Our extensive testing has found that this product meets the label claim.” Whole Foods did not respond to repeated requests for comment.

AFFECTED PRODUCTS

GNC HERBAL PLUS ECHINACEA EXTRACT
MASON NATURAL PREMIUM HERB ECHINACEA
WHOLE FOODS MARKET DOUBLE ECHINACEA

Products That Met CR’s Testing Criteria

Many products we tested met their label claims and did not exceed limits for heavy metals, such as lead, or for bacteria. That doesn’t mean that they’re safe or effective; it indicates that our tests showed that they are what they’re claimed to be and don’t have the contaminants we tested for.

PRODUCTS

GAIA HERBS ECHINACEA SUPREME
GAIA HERBS TURMERIC SUPREME
EXTRA STRENGTH
GNC HERBAL PLUS TURMERIC CURCUMIN
IRWIN NATURALS WHOLE-BODY
TURMERIC EXTRA
NATURE MADE TURMERIC CURCUMIN
NATURE’S BOUNTY TURMERIC
NATURE’S TRUTH ECHINACEA
NATURE’S WAY STANDARDIZED TURMERIC
OREGON’S WILD HARVEST ECHINACEA
QUNOL EXTRA STRENGTH
TURMERIC CURCUMIN COMPLEX
REXALL (DOLLAR GENERAL)
NATURALIST TURMERIC CURCUMIN
RITE AID PHARMACY ECHINACEA
SPRING VALLEY (WALMART) ECHINACEA
SUNDOWN NATURALS TURMERIC
UP & UP (TARGET) TURMERIC
THE VITAMIN SHOPPE ECHINACEA EXTRACT
THE VITAMIN SHOPPE TRIPLE
STRENGTH TURMERIC WITH CURCUMIN



GENERATOR SAFETY GUIDE

New technology that reduces the risk of carbon monoxide poisoning from portable generators could save your life. We've revamped our ratings to encourage manufacturers to make these safety features standard.

BY PAUL HOPE

USE PROPER CORDS

If you have a transfer switch, use the supplied cord. If you don't, buy outdoor-rated 12-gauge extension cords to connect individual appliances directly. Don't group multiple high-wattage appliances on one cord, even with a surge protector.

Always run a generator **at least 20 feet** from your house.

GET A TRANSFER SWITCH

Installed by an electrician, this safety device powers critical hardwired circuits while protecting utility workers from electrocution when power is restored.

KEEP IT DRY

To shield your portable generator from rain and snow, use an open-sided canopy that allows for a safe exchange of air.

PROTECT YOUR POWER

Install an eyebolt into a buried concrete block to tether your generator with a padlock.

Always **direct exhaust** away from any occupied space.

EXHAUST

Never run a generator **indoors**.

20 FEET

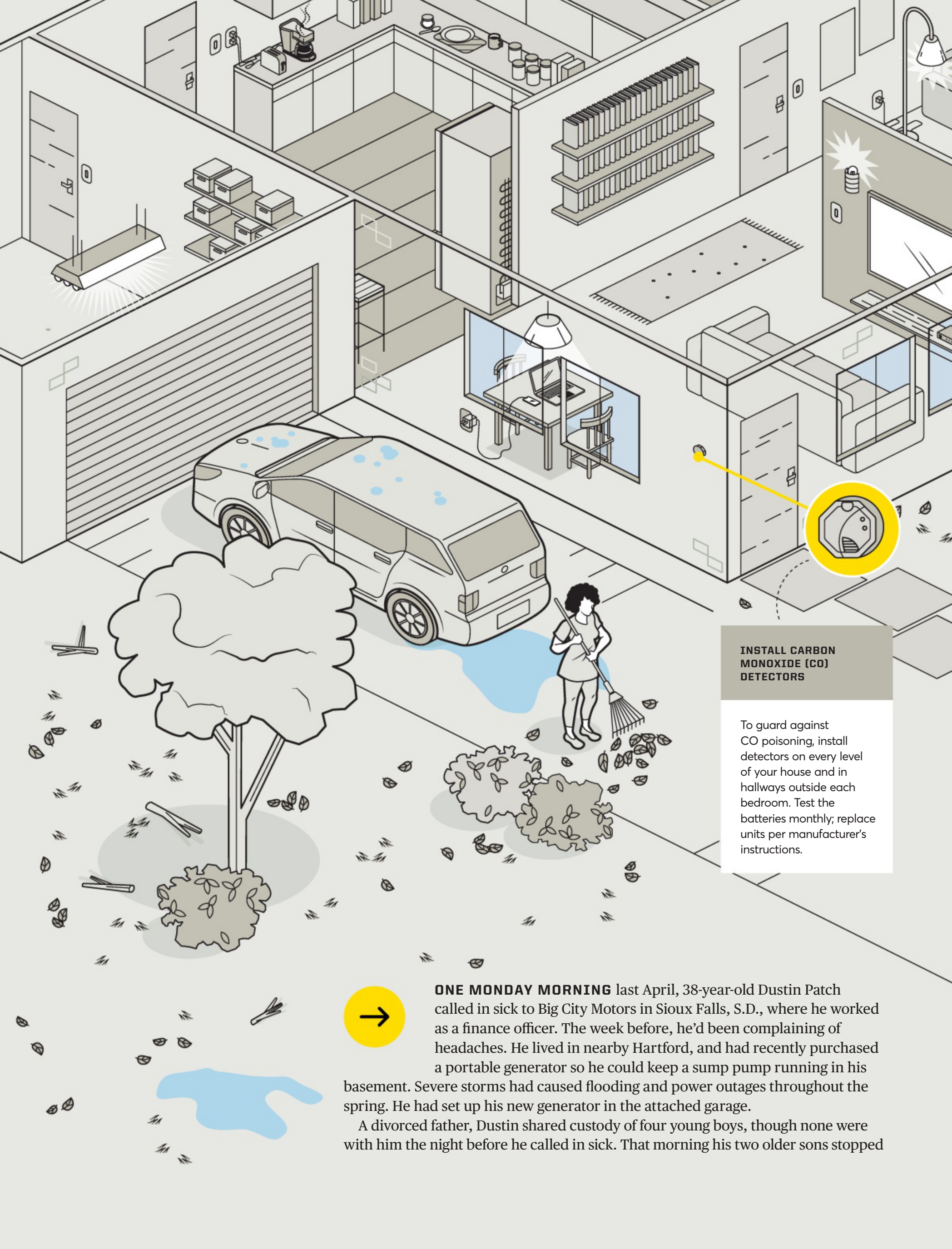

INSTALL CARBON MONOXIDE (CO) DETECTORS

To guard against CO poisoning, install detectors on every level of your house and in hallways outside each bedroom. Test the batteries monthly; replace units per manufacturer's instructions.



ONE MONDAY MORNING last April, 38-year-old Dustin Patch called in sick to Big City Motors in Sioux Falls, S.D., where he worked as a finance officer. The week before, he'd been complaining of headaches. He lived in nearby Hartford, and had recently purchased a portable generator so he could keep a sump pump running in his basement. Severe storms had caused flooding and power outages throughout the spring. He had set up his new generator in the attached garage.

A divorced father, Dustin shared custody of four young boys, though none were with him the night before he called in sick. That morning his two older sons stopped

by to grab their bikes and ride to school, and according to Dustin's mother, Sharon, he told them he didn't feel well. After school, his eldest son, Gavin, who is 12, found his father collapsed on the stairway from the kitchen to the garage. First responders pronounced him dead at the scene, and a death certificate would state that Dustin Patch died of carbon monoxide poisoning due to operating a generator inside.

"His basement had flooded just a few weeks earlier, and he was probably just working in a hurry because he didn't want it to happen again," says Sharon Patch. "He lived for those four boys, and he was such a good father."

A SILENT KILLER

Portable generators have long concerned safety advocates because their engines emit carbon monoxide (CO) at a high rate, and people may not be aware of the hazard posed by the deadly gas, which is colorless, odorless, and tasteless. From 2005 to 2017, more than 900 people died of carbon monoxide poisoning while using portable generators, according to the Consumer Product Safety Commission (CPSC), and about 15,400 people were sickened enough to require treatment at an emergency room.

"Carbon monoxide is called the silent killer not only because it's undetectable by the senses but because of the sequence in which it kills you," says David Farcy, M.D., an emergency room

physician in hurricane-battered Florida and president of the American Academy of Emergency Medicine. "While lower-level exposure might make you feel sick, at higher levels it can incapacitate you, not unlike excessive drinking. Many people fall asleep completely shortly before dying from the effects of the gas."

For many people, generators are emergency equipment they use under duress during power outages—desperate circumstances in which they don't always remember to follow safety guidelines. But like any other machine or tool with an engine, a generator should never be operated in an enclosed space. That goes for 2,000-watt units you might use for a tailgate party to 8,000-watt models on wheels that can power an entire house. (Home standby generators also produce carbon monoxide, but they don't pose the same threat because they're permanently installed outdoors and are typically subject to building codes designed to ensure safety.)

In about 93 percent of the deaths reported to the CPSC, the generator was inside the victim's living space. And in cases where the agency has data, there was an attempt to vent the exhaust outside about one-third of the time by cracking open a window, opening a garage door, or even with makeshift ductwork. At one point before he died, Dustin Patch had been running his generator in the garage with the garage door cracked open, according to his

mother. That's not even remotely safe. Consumer Reports' tests to re-create this scenario recorded dangerous CO levels.

IMPROVED TECHNOLOGY

To reduce the risk of carbon monoxide poisoning, some new generators feature a built-in sensor that triggers an automatic shutoff if the gas builds up to dangerous levels in an enclosed space, and some also have engines that emit less CO in the first place. Recent CR test data show that these safety features are likely to save lives. That's why we've revamped our portable generator ratings to reward models that have new safety features—and penalize those that don't.

"We believe safety technology is critical for portable generators, and as an organization we can no longer recommend any model that doesn't have some form of it," says Liam McCormack, CR's vice president of research, testing, and insights. "We're incentivizing the industry to move in the right direction, as we have in the past with innovative lifesaving features on cars, such as electronic stability control, which is now standard. The goal is to achieve broad adoption of effective generator safety technology, as we believe every consumer should have access to safe products."

CR recently tested five portable generators that have an automatic shutoff, and all passed our new CO safety technology test, shutting down before CO reached specified limits in our enclosed chamber. (See the ratings on the facing page.)

But our findings also revealed potentially life-threatening gaps that an automatic shut-off fails to address. When we ran an experiment simulating someone using a portable generator in the doorway of a garage—with the door open in an attempt at ventilation but with the exhaust directed inward—all five generators failed to shut off as CO quickly built up to unsafe levels.

"It's foreseeable that a homeowner could end up using a generator in an attached garage with the garage door open," says John Galeotafiore, an associate director for testing at CR. "After all, a generator shouldn't get wet, yet power outages often occur during rain or snowstorms. If a



"We believe safety technology is critical for portable generators, and as an organization we can no longer recommend any model that doesn't have some form of it. ... The goal is to achieve broad adoption of effective generator safety technology."

LIAM McCORMACK, vice president of research, testing, and insights at CR

person doesn't have a canopy to protect his generator, we can imagine why he might mistakenly think it's safe to run it near an open garage door."

It's not. With any generator, you should follow these three rules: Never run it indoors or in an enclosed space, always run it at least 20 feet away from your house, and always direct the exhaust away from any occupied space.

If you're shopping for a generator, look for marketing terms such as "CO Guard," "CO Protect," "CO Detect," "CO Shield," or "CO Sense." To verify whether a generator meets one of two voluntary standards the industry follows, check the packaging for one of these references: "ANSI/UL2201 Certified for Carbon Monoxide Safety" or "ANSI/PGMA G300 Certified Safety & Performance."

Each standard specifies a peak level and a lower level for sustained exposure to the gas, which relates to the technology and how CO affects human physiology.

Symptoms like headaches and dizziness generally occur at CO levels from 70 to 150 parts per million (ppm), which a typical generator can produce in minutes. You can die from sustained levels above 150 to 200 ppm, according to the CPSC's safety guide on carbon monoxide.

Our testing revealed differences in how safety features work, based on which standard a generator meets.

COMPETING STANDARDS

One standard was created by the Portable Generator Manufacturers' Association (PGMA), a trade group, and approved by the American National Standards Institute (ANSI). For a generator to meet the PGMA standard, it must have a shut-off mechanism that automatically stops the engine before carbon monoxide reaches 800 ppm or the average exceeds 400 ppm over any 10-minute period. "Our standard came about after a review of CPSC data that showed nearly all deaths associated with carbon monoxide from generators occurred in enclosed spaces or indoors," says Joe Harding, technical director at PGMA. "It's been tested in thousands of simulations and is designed to protect consumers and prevent nearly all deaths."



5 OF THE SAFEST GENERATORS

A portable generator must have an automatic CO shutoff and meet certain performance benchmarks to earn a CR recommendation. These five models all have the shutoff.

✓ **Ryobi**
RY907022F (7,000W)
\$1,150
78
8-14 HOURS RUN TIME

✓ **DeWalt**
PMC168000 (8,000W)
\$1,050
77
9-17 HOURS RUN TIME

✓ **Generac**
7675 (8,000W)
\$1,000
73
9-15 HOURS RUN TIME

Champion
100592 (6,250W)
\$700
65
7-12 HOURS RUN TIME

Craftsman
030731 (5,000W)
\$600
64
11-20 HOURS RUN TIME

The other safety standard comes from UL, which sets and certifies product safety standards. For a generator to meet the UL 2201 carbon monoxide safety standard, in addition to having an automatic shutoff, its engine must significantly reduce carbon monoxide emissions. UL's shutoff levels are lower than PGMA's: a 150 ppm average during a 10-minute period or a peak of 400 ppm. It's a belt-and-suspenders approach that so far has been adopted by both Techtronic Industries (TTI), which makes brands including Ryobi, and Echo.

Michael Gardner, TTI's vice president of new product development, says the company's rationale is based on a broad view of the risk. "Our review of the data led us to believe that after a hurricane, many people are running a generator for 24 hours a day—and often in close proximity to the house to prevent it from being stolen," he says. "That realization led us to conclude we needed to develop generators that addressed the perils of outdoor use, too. And that automatic CO shutoffs alone weren't enough."

The CPSC is reviewing data on both standards to determine whether compliance with either, or some combination of the two, will adequately protect consumers. In the meantime, because the standards are voluntary, it's entirely up to manufacturers to comply with one or the other—or neither.

Gardner told CR that going forward, all of TTI's new generators will be equipped with one safety feature or more to mitigate the risk of CO poisoning. Generac told CR that it has introduced nine new models with an automatic CO shutoff. "Generac is committed to the safety of all portable generator users," says Ryan Schmitt, its product manager for portable generators and accessories.

Consumer Reports says that having two separate standards isn't ideal.

"Manufacturers now have two voluntary safety standards intended to help reduce the CO hazard," says William Wallace, CR's manager of home and safety policy. "Ultimately, to best protect consumers, there should be a single, stronger standard enforced by the Consumer Product Safety Commission."



TAINED FOOD

THE DEPARTMENT OF AGRICULTURE CAN'T FORCE RECALLS OF CONTAMINATED MEAT, LEAVING THAT TO THE COMPANIES THEMSELVES. AS A RESULT, FOOD CAN BE SOLD EVEN AFTER IT HAS BEEN LINKED TO ILLNESS.

When

Recalls

Fail

Harmful products are supposed to stay out of the reach of consumers. Yet many dangerous items remain in homes and stores. Why that happens, what needs to change, and how to protect yourself.

by
Rachel
Rabkin
Peachman

Illustrations
by
Joan
Wong

ANTIBIOTIC-RESISTANT strains of salmonella are linked to contaminated chicken, sickening many and hospitalizing more than 200 people for almost a year and a half, though it was known that the plants processing the chicken had failed federal food safety standards. *Why did the outbreak go on for so long before the unsafe chicken was pulled from store shelves?*

A breast implant lacking premarket safety research is linked to a rare cancer, but years pass and women die before regulators acknowledge the connection and a manufacturer recalls the devices. *Why did it take patient outcry before the potentially deadly implants were taken off the market?*

An inclined sleeper for babies is put on the market without adequate safety testing or adherence to infant sleep guidelines. Over the next decade, as the sleeper becomes a best seller, dozens of babies die while using it. *Why did it take public exposure before the manufacturer recalled the product?*

In 21st century America, it's easy to assume that the products we put on our plates, in our homes, and in our bodies are safe and effective. Many people expect that we have robust consumer protections in place—a system that vets products thoroughly before allowing them to be sold and that recalls products swiftly if they prove to be dangerous.

But product safety regulation and the recall process are part of a complicated and imperfect system that varies widely depending on the type of product, the industries involved, and the government agencies tasked with overseeing it. For instance, a recall does not get put into motion automatically when a product is known to cause harm. Recalls, if they happen at all, can take years to be initiated, often only after public protest and sometimes following injuries or deaths.

Moreover, when a recall is issued, consumers often aren't made aware. Almost 70 percent of Americans said that they had not heard about a recall in the past five years for any product they own, according to a Consumer Reports nationally representative survey of 1,010 adults, though millions of products are recalled each year. And only 21 percent of Americans said they had heard about a recall and responded

to it in that time frame. Of those, about two-thirds said the issue had to do with their car, 19 percent said it involved food, 9 percent a health product, and 9 percent a children's product.

That disparity is not surprising, says David Friedman, CR's vice president of advocacy and a former acting administrator of the National Highway Traffic Safety Administration. Unlike other federal agencies, NHTSA requires manufacturers to notify car owners directly about recalls. To track recalls, it helps that every car has a unique vehicle identification number and every owner has a registration. Other agencies—the Food and Drug Administration, the Department of Agriculture, and the Consumer Product Safety Commission—generally have fewer tools and requirements for recalls. In some cases, laws can actually shield agencies from accountability and protect companies from liability, Friedman says.

Even when consumers learn about a recall, they often aren't given simple, effective ways to respond. Some entail disassembling and mailing in part of the product for a refund, or not using the product until a replacement part is mailed—a process that can take months. As a result, many recalled products remain in use, risking further injury.

How, then, can consumers ensure that the products they buy have been safety tested and have not caused problems since their release? In some cases, it's impossible to fully know. But the examples described here provide a sense of how regulatory oversight sometimes works for—and against—consumers. Plus, we share steps you can take to protect yourself and your family.

Contaminated Chicken

Noah Craten, of Glendale, Ariz., was 17 months old in October 2013 when he developed a fever that wouldn't let up. Three weeks later, after multiple trips to the doctor, the toddler was found to have a life-threatening brain abscess caused by a bacterium called Salmonella Heidelberg.

Just before Noah got sick, his grandmother—who often ate with the family—got food poisoning and was diagnosed with a salmonella infection. But the pediatrician ruled out salmonella because the boy didn't have severe gastrointestinal symptoms, says Amanda Craten, Noah's mom. Yet after Noah had brain surgery and doctors tested the abscess fluid, they learned his illness was caused by a salmonella strain traced to chicken from Foster Farms, a major poultry producer. The family regularly ate that chicken, according to a lawsuit the Cratens ultimately won against the company.

"I was sobbing when he told me it was salmonella, because I suspected it from the beginning," Craten says.

Noah, now 7, and his grandmother were among a reported 634 people across the U.S. who became ill during a multistate salmonella outbreak linked to Foster Farms chicken that began in March 2013. It wasn't until July 2014—16 months later—that the company issued a recall, one that included only a small portion of chicken produced over those months.

Noah still lives with a severe brain injury that impairs his speech and vision and affects his behavior. The Cratens believe the infection could

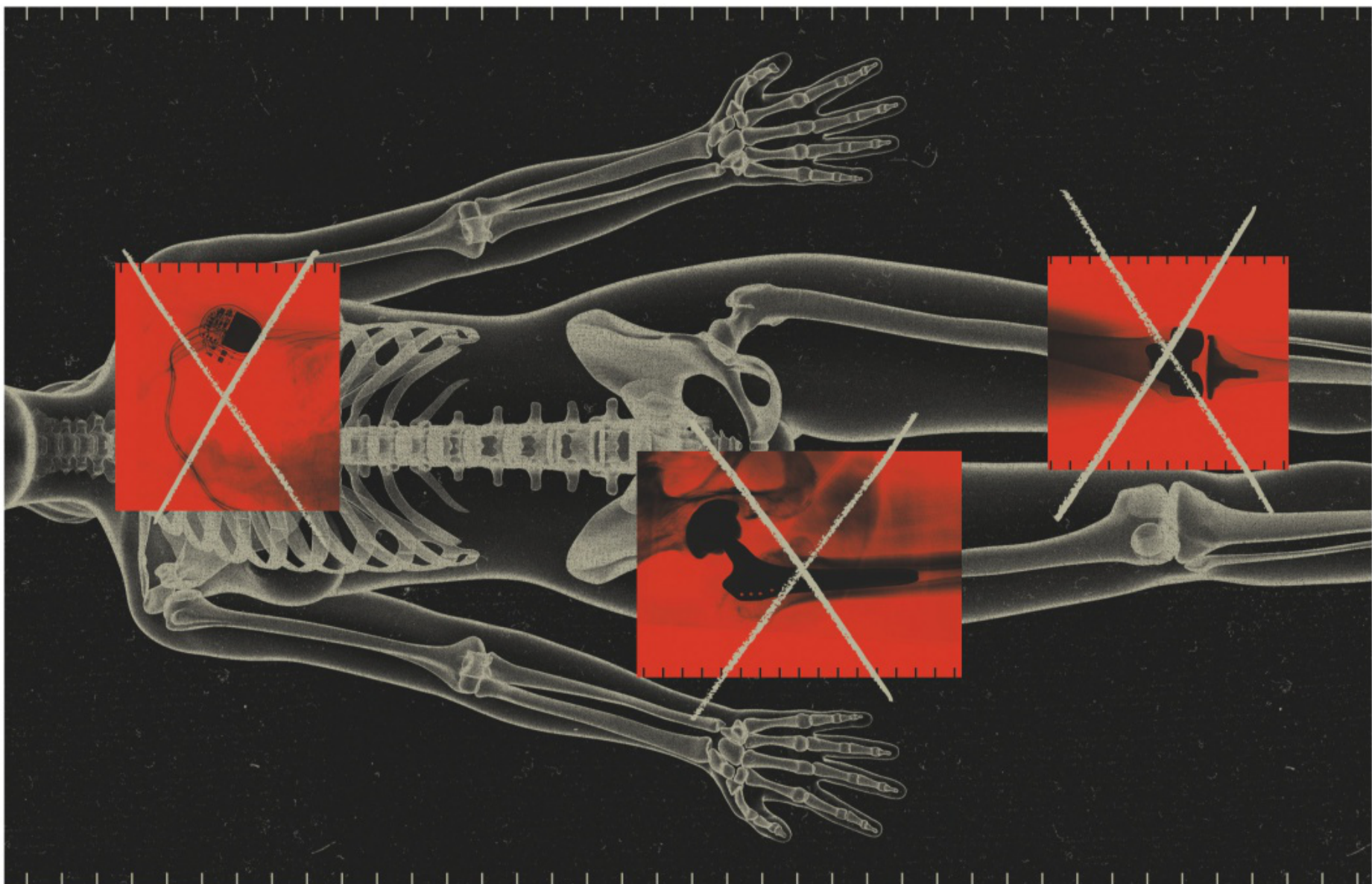

UNPROVEN MEDICAL DEVICES

PACEMAKERS, JOINT REPLACEMENTS, AND OTHER IMPLANTABLE DEVICES OFTEN DON'T UNDERGO RIGOROUS PREMARKET TESTING, SO PROBLEMS MAY EMERGE ONLY AFTER THEY'RE USED IN PEOPLE.

have been avoided if Foster Farms had implemented stronger food safety protocols and had taken responsibility faster, and if the USDA had been able to take tougher enforcement actions.

Why didn't Foster Farms issue a recall sooner? For one thing, it didn't have to. The USDA's Food Safety and Inspection Service (FSIS) can't force food producers to recall food, even if it has sickened consumers for months. Advocates have long urged giving the USDA more recall power, something producers oppose. "It's a big political hurdle," says Michael Taylor, a former FSIS administrator and FDA deputy commissioner who is now co-chairman of the board of Stop Foodborne Illness, a food safety group.

What the FSIS can do: send warning letters to companies, issue public health alerts, seize products, and request a voluntary recall, among other tactics. But it's up to the company to initiate a recall.

An FSIS spokesperson told CR that "mandatory recall authority would not enable the agency to do anything that it doesn't already have the power to do in order to protect public health."

Consumer advocates disagree. In the case of Foster Farms, the FSIS cited the company's processing plants more than 480 times during the outbreak for not complying with food safety standards. Yet business was allowed to continue as people got sick. In October 2013, CR also urged the company to recall after our tests found salmonella isolated from a Foster Farms sample that matched an outbreak strain. But the chicken remained on store shelves.

A second reason Foster Farms didn't act faster: The FSIS doesn't consider salmonella an adulterant (a forbidden contaminant) in meat partly because it's so common on farms and in

animals, says Pat Basu, D.V.M., former FSIS chief public health veterinarian. So producers don't have to withhold or recall chicken with the bacteria.

Instead, the burden is on the consumer "to cook the chicken well, to the recommended 165 degrees, and not cross-contaminate the kitchen," says Francisco Diez-Gonzalez, Ph.D., director of the Center for Food Safety at the University of Georgia.

Despite that approach, salmonella still causes about 1.2 million illnesses, 23,000 hospitalizations, and 450 deaths in the U.S. each year, according to the Centers for Disease Control and Prevention.

A separate problem: The FSIS doesn't oversee the farms where food animals are raised. That's the jurisdiction of the USDA's Animal and Plant Health Inspection Service, which regulates animal health and welfare, not food safety. "The USDA's [food safety] authority begins at the threshold of the slaughterhouse and ends on the loading dock," says Sandra Eskin, director of food safety at The Pew Charitable Trusts, a public interest group.

Yet back on the farm, “there are extremely high rates of infections,” says Taylor, the former FSIS and FDA official. “It’s a problem when you know where the issue originates yet it’s not subject to regulation.”

Other factors can delay food recalls. Diez-Gonzalez notes that it takes time, resources, and coordination between hospitals, health agencies, and patients, who have to itemize what they recently ate. “It can be a challenge to determine what sickened individuals have in common,” he says.

That difficulty not only impacts the USDA, which oversees meat and poultry, but also the FDA, which oversees most other foods, from leafy greens to packaged foods.

Last, after regulators identify a likely outbreak source, the threshold to prove a link is high. “Investigators are looking for the smoking gun,” Diez-Gonzalez says. So while hundreds of people said they’d eaten Foster Farms chicken and tested positive for an outbreak strain, the recall didn’t happen until FSIS inspectors found an unopened package of contaminated Foster Farms chicken in the freezer of a patient who’d tested positive for the same strain and had proof of its purchase.

“It’s an unreasonably narrow standard that FSIS is applying,” says Thomas Gremillion, director of food policy at the Consumer Federation of America. “It’s just bewildering.”

Since the outbreak, the FSIS established tougher standards for salmonella in chicken, and Foster Farms invested more than \$75 million in food safety. When CR asked why the company didn’t recall its chicken sooner, Foster Farms declined to comment directly but noted that since April 2014, tests found salmonella in less than 5 percent of its chicken, much lower than what the USDA allows.

Though reducing salmonella in meat is a step in the right direction, “we haven’t seen that translate into reduced cases of human illness” overall, says

Sarah Sorscher, a deputy director at the advocacy group Center for Science in the Public Interest. She suggests that for substantial change, farmers should do more to prevent infection by, for example, using animal vaccines.

Eskin, at Pew, argues that the USDA should have the power to enforce food safety standards from the farm to the retailer—and the power to mandate recalls.

While some in the industry support change, progress can be slow. “Sadly, it takes disasters, more outbreaks, more coverage, and more questioning by

Recalls That Made a Difference

When seven people died in **1982** after taking **Extra Strength Tylenol** that had been laced with cyanide, Johnson & Johnson acted quickly and ultimately recalled 31 million bottles of the pain reliever. The Food and Drug Administration responded, too, developing standards for tamper-resistant packaging. The fast response to the still-unsolved crime became a model for how to react to safety problems. And changes such as foil seals on over-the-counter drugs show how recalls can lead to safer products. At right, eight recalls over the last 20 years that helped create a safer marketplace for consumers.

—Donna Rosato



FIRESTONE TIRES

Firestone recalled 14.4 million tires after defects caused blowouts contributing to more than 200 deaths and 500 injuries. Firestone’s slow response helped spur the **TREAD Act**, which requires carmakers to inform the government of potential defects and made tire pressure warning lights mandatory.

MERCK VIOXX

The recall of this pain drug, after being linked to heart attacks and strokes, helped lead to the **Food and Drug Administration Amendments Act of 2007**. The law helps prevent drug companies from downplaying side effects and gives the FDA more clout in overseeing medications.

consumers,” Taylor says.

In the meantime, it’s key for consumers to curb contamination in food at home, says James E. Rogers, Ph.D., CR’s director of food safety research and testing and a former FSIS microbiologist. He advises storing meat in disposable bags apart from other foods; not washing raw meat, which spreads bacteria; using a separate cutting board for meat; washing counters, utensils, and hands after handling meat; and using a meat thermometer to ensure that you cook to recommended temperatures.

PHOTOS, FROM LEFT: MARK WILSON/GETTY IMAGES; AP PHOTO/MIKE DERER; CHICAGO TRIBUNE/GETTY IMAGES; TOM WILLIAMS/GETTY IMAGES; AP PHOTO/J. SCOTT APPLEWHITE; CONSUMER REPORTS

fference for Consumers



2007



SIMPLICITY CRIBS

About a million cribs with drop-side rails were recalled after being tied to infant deaths and injuries. The recall contributed to the landmark **Consumer Product Safety Improvement Act**, which created **SaferProducts.gov**, where consumers can report and search for problems linked to products.

2008



TAKATA AIRBAGS

This recall, now affecting more than 40 million vehicles with inflators that could cause airbags to rupture in crashes, prompted Honda and other automakers to use more aggressive tactics to track down open recalls, including using social media, ads at professional sports events, and hiring private detectives.

2009



PEANUT CORP. OF AMERICA

Hundreds of companies recalled thousands of products with salmonella-contaminated peanuts from Peanut Corp. The outbreak, which sickened more than 700 people, helped lead to the **Food Safety Modernization Act**, which directed the FDA to focus more on prevention.

2014



GM IGNITIONS

General Motors recalled 2.6 million cars due to ignition switches that shut down engines while driving. GM paid \$900 million as part of a settlement of criminal charges after admitting it concealed the defect from regulators. The case boosted penalties on automakers that fail to quickly recall and repair cars.

2017



IKEA DRESSERS

Ikea's recall of 17 million dressers that were unstable when not anchored to walls was a catalyst for the **Stop Tip-overs of Unstable, Risky Dressers on Youth Act**, which has passed the House and is now in the Senate. Tip-overs of clothing storage units have been linked to at least 206 deaths since 2000.

2019



FISHER-PRICE INFANT SLEEPERS

Fisher-Price recalled nearly 5 million infant inclined sleepers after a CR investigation linked the products to dozens of deaths. After CR's report, there were more recalls, including from Kids II for 700,000 sleepers and one by Dorel for 24,000. Legislation has also been introduced to ban infant inclined sleepers.

Dangerous Breast Implants

Raylene Hollrah was 33 years old in 2007 when she was diagnosed with breast cancer and underwent a mastectomy. A year and a half later, when she was ready for reconstructive surgery, she chose a silicone-filled implant with a textured surface made by Allergan. Hollrah, from Hermann, Mo., believed a selling point of the implant was that she'd automatically be enrolled in a 10-year study "so I could help other women," she says.

What Hollrah didn't know is that medical devices—including breast

implants, artificial joints, and pacemakers—are subject to much less rigorous premarket testing than drugs are. That's partly because the FDA didn't begin regulating medical devices or requiring research on their efficacy and safety until 1976, after many devices were already in use.

Silicone breast implants were introduced in the 1960s with little to no safety research, says Diana Zuckerman, Ph.D., president of the National Center for Health Research. Even after the FDA began regulating them, the agency didn't require premarket studies until

1991—when it determined there was insufficient safety research, and soon after put a moratorium on sales.

In 2006, when the FDA did approve silicone implants, it was on the condition that manufacturers conduct post-market studies, one of which included Hollrah. But that wasn't made clear to her early on. And as time passed, more problems emerged. In 2011, the FDA announced a link between silicone- and saline-filled implants and a form of cancer called anaplastic large cell lymphoma (ALCL).

But Hollrah didn't learn about breast

implant associated ALCL, or BIA-ALCL, until 2013, when one of her implants swelled and she tested positive. “I removed breast cancer,” Hollrah says, “and then I put something right back in my body that gave me cancer again.”

Around the time of Hollrah’s diagnosis, Allergan dropped her from its post-approval study. In fact, Allergan lost track of many participants, in part because it was difficult to follow up with the women, who were given no real incentives to stay involved in the studies, Zuckerman says. As a result, the research was never completed. Yet the FDA did not penalize manufacturers or recall the implants.

Fortunately for Hollrah, her cancer was caught early. She had her implants removed in 2013 and is now cancer-free.

But it wasn’t until July 2019 that the FDA announced the recall of Allergan’s textured implants due to a reported worldwide total of 573 BIA-ALCL cases,

481 of them from Allergan, including 33 deaths.

When asked why it took eight years after the FDA acknowledged the risk of BIA-ALCL for the agency to request a recall, an FDA spokesperson said it took the action after learning, in the spring of 2019, of “a significant increase in known cases of BIA-ALCL.”

Though the recall is a victory for women affected by BIA-ALCL, other concerns remain. For one, “when medical devices are recalled, there’s typically not a rigorous process to reclaim the flawed products,” says Lisa McGiffert, a co-founder of the Patient Safety Action Network and a former patient-safety expert at CR.

There’s also no established system for device manufacturers to find and notify doctors and patients about a recall. Hollrah notes that she has yet to receive a recall notification from Allergan.

For its part, Allergan says that “patient safety is a priority” and that it is committed to ensuring the safe and effective use of its products.

Still, hundreds of thousands of women are estimated to have a recalled device in their bodies and no easy choices. The

FDA recommends implant removal only for women with a diagnosis of BIA-ALCL. But women don’t always have obvious symptoms. “Although BIA-ALCL is treatable if caught early, no one wants to wait to see if they get cancer,” says Sara Castro, an attorney at Farr law firm in Punta Gorda, Fla., who is working with affected women.

Another hurdle: Though Allergan will pay for replacement implants in the case of a cancer diagnosis or implant defect, it doesn’t cover the surgical costs of preventive implant removal. Most insurers won’t cover it, either.

Scot Glasberg, M.D., past president of the American Society of Plastic Surgeons and a consultant for Allergan, says that “if a woman has any concerns whatsoever, she should see a plastic surgeon who is board certified,” specializes in breast implants, and is knowledgeable about BIA-ALCL to go over her screening and testing options.

Women considering breast-implant surgery (or any medical device procedure) should ask their surgeon for an informed consent form that details what the device contains, and known risks. “This form is not mandated yet,” says Hollrah, who did not have that protection before her surgery and has since worked with Zuckerman, Glasberg, and others to create one.

Madris Tomes, a former program manager at the FDA who now runs Device Events—which gathers adverse event reports on medical devices—recommends researching your device. One free source is an online FDA database called MAUDE (Manufacturer and User Facility Device Experience). “Two-thirds of all recalls begin as an adverse event report,” Tomes says.

HARMFUL CONSUMER GOODS

WEAK REGULATIONS MEAN THAT HAZARDOUS PRODUCTS, LIKE INFANT INCLINED SLEEPERS, CAN REMAIN FOR SALE.



Risky Infant Sleepers

When family asked Hailey and Ty Hampton what they needed before the birth of their twin boys, Liam and Lennox, the couple didn’t hesitate: two Fisher-Price Rock ‘n Play Sleepers. Other new parents were raving about them. The Hamptons, from Nauvoo, Ala., wanted the babies to sleep in the couple’s bedroom but not in their

bed, which they knew was dangerous. “The Rock ’n Play Sleepers were our alternative,” Ty says.

But on Feb. 20, 2019, when Ty went to give the twins their bottles, he noticed Liam’s head was tilted oddly in the sleeper, according to a lawsuit the Hamptons filed against Fisher-Price. When Ty picked up the baby, his body was limp and cold. After frantic efforts to revive him, Liam was pronounced dead at the hospital.

The Hamptons, devastated, had no idea what caused Liam’s death. But less than two months later, they learned that dozens of other infants had died in Rock ’n Play Sleepers and that Fisher-Price and the CPSC had known about the deaths for years.

Like many parents, the Hamptons had assumed the sleeper was safe. But a CR investigation published in April found that it had never been adequately tested and posed several risks. Medical guidelines say babies should sleep on their backs, alone, unrestrained, on a firm, flat surface free of soft bedding. But the Rock ’n Play Sleeper positions babies at an angle of about 30 degrees, which may cause a baby’s head to tilt forward, compressing the airway and leading to suffocation. It also has soft padding and restraints, which increase the risks of suffocation and strangulation.

It was only after CR linked the sleepers with at least 32 infant deaths going back to 2011 that Fisher-Price recalled almost 5 million of them. At least 54 infants are now known to have died in these or similar sleepers.

William Wallace, CR’s manager of home and safety policy, says the recall was long overdue. “It’s outrageous that Fisher-Price and the CPSC knew about deaths linked to this product for years and didn’t take steps that could have prevented tragedies.”

When CR asked Fisher-Price in early April about the deaths associated with the Rock ’n Play Sleeper, a company spokesperson said, “We do not believe

any deaths have been caused by the product,” and noted that some of the fatalities were due to mitigating circumstances or the product not being used according to instructions.

How could so many deaths not warrant a recall? At the heart of the holdup is a controversial law that restricts and sometimes prevents the CPSC from

releasing company- and product-specific information, even when the products are connected to injuries or deaths.

The law, called Section 6(b) of the Consumer Product Safety Act, says that in most cases the agency must get a company’s permission before it publicly reveals a safety problem. And once a company agrees, the two negotiate the

What Consumers Should Do

RESPOND TO RECALLS: If a product you own has been recalled, follow the manufacturer’s instructions—by calling the company or checking its website—on how to repair or return it. If you choose not to participate in the recall, don’t give the product away or sell it. Instead, throw it out so that it can’t be used by others.

STAY INFORMED: Track recalls and safety alerts at [recalls.gov](https://www.recalls.gov), which will direct you to each federal agency’s recalls page. That includes the Consumer Product Safety Commission (household and other products), the Department of Agriculture (meat, poultry, and egg products), the Food and Drug Administration (most other foods, medical devices, drugs, and supplements), and the National Highway Traffic Safety Administration (vehicles, car seats, and related equipment). At each site, you can see recalls and sign up to receive email alerts. CR members can also track recalls related to their vehicles at [CR.org/carrecalls](https://www.cro.org/carrecalls).

REPORT PROBLEMS: Each agency’s recalls page also

provides a way for consumers to report problems relating to the products it regulates.

REGISTER YOUR PRODUCTS: If your product comes with a registration card, don’t toss it. Instead, fill it out and mail it in or, if possible, fill it out online. That allows the company to notify you if the product is recalled or needs a repair.

RESEARCH SECONDHAND PURCHASES: Though it’s illegal for retailers and individuals to sell new or used products that have been recalled, some sellers, particularly of used goods, may not adhere to this law consistently. Policies are more uneven with used-car dealers, because federal law does not explicitly prohibit the sale of used vehicles with open recalls. When buying any used product from an individual, ask for the brand, model, serial number, and date the product was manufactured. That information is often on the product itself or in the instruction manual. Also, take extra care when buying used cars; look up the VIN number on [nhtsa.gov/recalls#vin](https://www.nhtsa.gov/recalls#vin) to see whether the car is part of a recall.

terms of the alert, which can allow the company to downplay the problem.

Proponents of 6(b) say that by giving companies a chance to review safety concerns first, the law prevents the CPSC from unfairly damaging a company's reputation.

Critics disagree. "The gag that 6(b) places on the CPSC is a dangerous anomaly," says CR's Friedman. NHTSA could push "for the recall of deadly Takata airbags because we had the freedom to share what we knew," he says. "The CPSC can't do that."

While the delayed recall of the Rock 'n Play Sleeper—and the lives lost while it stayed on the market—is a glaring example of what can happen when product hazards are shrouded in secrecy, it's not an isolated case. Section 6(b) also hid for years the number of tip-over deaths associated with Ikea furniture, delaying the recall of millions of dressers.

Though the CPSC can technically mandate a recall, it rarely takes that step, in part because companies could sue the agency, says Pamela Gilbert,

previously CPSC's executive director.

The agency does not have an official stance on Section 6(b), but two members—Robert Adler, acting chairman, and Elliot Kaye, commissioner—have spoken against it. "We need the anti-consumer safety and anti-transparency requirements of Section 6(b) ... to be eliminated," Kaye said recently. "People die because of Section 6(b). It is that simple."

Even when recalls are initiated, it's often hard to remove products from circulation. As CR's recent survey showed, most Americans don't hear about, much less respond to, product recalls. And most companies recalling products don't face strict requirements to reach out to consumers. As a result, recall completion rates are often less than 10 percent, according to the CPSC.

In fact, 1 in 10 day care centers was still using Rock 'n Play Sleepers or other inclined sleepers months after the recalls were announced, according to a report focused on three states by U.S. PIRG and Kids in Danger (KID), two consumer-safety advocacy groups.

"Industry should make the same multifaceted efforts they do to advertise their products to notify consumers about recalls, and then take more significant steps to retrieve recalled items," says Nancy Cowles, executive director of KID. "And government needs to be a strong advocate for consumers by enforcing product safety regulations both pre- and post-market."

KID is one of several groups, including the American Academy of Pediatrics and CR, that urges parents not to use infant inclined sleepers and supports a bill banning them, which was introduced after the April recall.

The CPSC's Adler explains that while recalls should be improved, "we also need to keep dangerous products from getting into the market in the first place," he says. "You want agencies like CPSC to be the fence at the top of the cliff, not the ambulance at the bottom."

How Future Recalls Can Be Better

TECHNOLOGY IS ALREADY making the recall process safer and more efficient. In December 2016, owners of more than 100,000 Samsung Galaxy Note7 phones, which were prone to battery fires, had failed to return their devices, despite earlier recalls. So Samsung, working with major U.S. carriers, pushed a software update that "bricked" the unreturned Note7s. The update rendered the phones unusable, unable to charge or connect to a network.

Robert Adler, acting chairman of the Consumer Product Safety Commission, thinks something similar—attaching wireless chips to consumer products—could improve recall rates. He envisions a future where "the crib is flashing a red light that says, 'Do not put your precious baby in me. I've been recalled and here's what you need to do to fix the problem.'"

Some companies can already fix problems "over the air." In

2018, CR found that the braking distance on the Tesla Model 3 was 152 feet at 60 mph, worse than any other contemporary car. Tesla pushed a software update that cut the distance by 19 feet, putting it in line with its peers. "I've tested more than 1,000 cars," says Jake Fisher, director of auto testing at CR, "and I had never seen a car that could improve performance with an over-the-air update."

Quick fixes can also introduce defects, Fisher cautions. Last year, SiriusXM pushed an update that caused the infotainment system in some Fiat Chrysler models to endlessly reboot. "Not only was it annoying," Fisher says, "but it made the federally mandated backup camera useless."

Still, despite these glitches, Fisher says, "if we can get these updates right, it just might revolutionize the future of product and car safety."

—*Jake Swearingen*



STAY AHEAD
OF THE CURVE
WITH CR AUTO
RATINGS, NEWS
& ADVICE™

ROAD REPORT

DASHBOARD DECODER

What Does
This Icon
Mean?



- ❑ The Avengers are on the way
- ❑ Automatic turning stabilizer is engaged
- ❑ The engine is in awesome shape
- ❑ The auto stop/start system is functioning

This symbol identifies the automatic stop/start system, a fuel-saving feature found on most vehicles sold today. The system stops the engine when the car or truck is brought to a standstill (such as at a stoplight), then restarts it when the brake pedal is released.

ASK OUR EXPERTS

How should I store my car when I won't need it for a while?

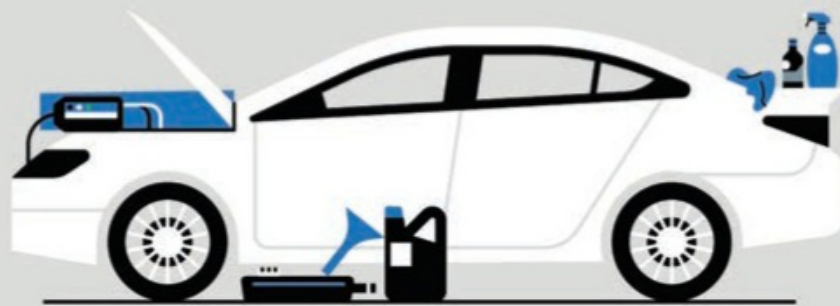

STORING A VEHICLE for an extended time period requires more than just parking it in your garage:

Wash and wax the body to prevent accumulated dirt, bugs, or tree sap from bonding to the surface.

Change the oil and oil filter to prevent contaminants from sitting in the engine.

Use a battery maintainer to keep the battery topped off without damaging it by overcharging.

Leave the hood open (because rodents like dark spaces) and use rodent repellent or mothballs, stashed in pantyhose, to discourage critters from nesting or chewing engine wiring.

THE VITAL STATISTIC

71%

Percentage of drivers ages 34 and younger who say their vehicle's automatic emergency braking (AEB) system helped them avoid a crash. Just 53 percent of those ages 65 and older say that AEB similarly helped them.

Source: CR survey data.

RECALL



GM SUVs and Trucks

General Motors is recalling almost 3.5 million vehicles because the brake assist system may fail, which could require more distance to stop, potentially leading to a crash. The recall affects Chevrolet Silverado and GMC Sierra pickup trucks and Chevrolet Tahoe, GMC Yukon, Chevrolet Suburban, and Cadillac Escalade SUVs. The vehicles were manufactured between 2014 and 2018.

What to do: Dealers will update the software at no charge. Go to my.gm.com/recalls for more information.

TRENDS

Traveling Light

A recent study showed that 48 percent of car trips in the 25 most congested U.S. cities are 3 miles or less, and concluded that replacing those trips with "micromobility"—or shared bicycles, e-bikes, and e-scooters—would cut emissions and could ease congestion. More than half the trips in the following cities are 3 miles or less.



TRIPS IN MILES	0-1	1-2	2-3
Honolulu	25%	19%	12%
New Orleans	22%	17%	12%
Nashville	22%	17%	12%
Chicago	22%	17%	12%
Charlotte	20%	18%	13%

Source: INRIX Research.

The Wheel Deal

To be confident in your tire purchase, use our ratings and the advice of our experts, who put tires through the most rigorous independent testing program in the country.

by Jeff S. Bartlett

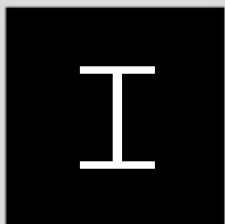

IN A PERFECT world, tire purchases would be planned ahead of time, so you could research the best deals

for a safe, high-performing product. This is especially true when winter approaches, the time of year you're more likely to need extra grip to battle heavy rain, snow, and icy roads.

But what if you get a flat that requires you to quickly replace one tire, and the other three are just fine? Or your mechanic surprises you with the news that your tires are worn and need to be replaced soon—maybe even right now?

Buying under those conditions can be stressful, confusing, and expensive. That's why it's best to arm yourself ahead of time with expert insights drawn from CR's extensive tire testing program. Here, we provide answers to tricky but common questions about buying tires. And the results from our latest tire retailer survey can show you the best places to shop,

based on CR member experiences at a wide range of stores.

What if I need to replace only a single tire?

For a tire that's damaged beyond a simple repair, you may be able to get away with replacing just that one if the other three show only light treadwear.

If the other tire on the same axle shows significant wear, we suggest you buy at least two new, matched tires. You'll want to put this new pair on the rear to ensure vehicle stability.

For an all-wheel-drive vehicle, you may have to replace all four tires because the AWD components can be particularly sensitive to a mismatch. Following this advice will ensure balanced handling and traction at all corners. Plus, replacing all four tires means you're free to consider a different model with higher performance and longer tread life. (More than 60 percent of CR members surveyed changed the brand and/or model with their most recent tire purchase.) It also could result in a

better overall deal from the tire retailer.

Here's a clever maneuver when buying just one tire: You can have the tread of the new tire shaved down by a machine to match the depth of the other three. This service costs \$25 to \$35 per tire through Tire Rack, an online retailer.

Can I mix and match tire brands on the same car?

We don't recommend this. Certainly never mix tire types, such as all-season and winter/snow, because it could be unsafe. If you decide to buy just one or two tires, stick with the brand and model already on the car. Of course, you want the same size, load index (how much weight each tire can support), and speed rating, too. This ensures that the vehicle dynamics are not upset by varying performance, which might pose a safety risk.

How much can I trust treadwear predictions?

The answer: It's very complicated. A treadwear rating (known as Uniform Tire Quality Grading, or UTQG) is a



comparative rating. The higher the number, the longer the tread life. For example, a tire graded 400 would wear four times as long as one graded 100. Manufacturers assign the grades for their own tires. The treadwear ratings, along with those for temperature and traction, are on the sidewall. Even so, there's no cited mileage that's easy for shoppers to understand.

Treadwear warranties, which offer insurance based on miles used, do provide some guidance for shoppers. But it can still be largely an apples-to-oranges comparison from brand to brand. Real-world tread life depends on multiple factors, such as vehicle, driving style, geography, tire pressure, road surface, temperatures, and wheel alignment.

To remove all this guesswork, CR predicts how long tires will last based on 16,000 or 20,000 miles of on-the-road testing and precise measurements. We conduct our extensive treadwear testing the same way within each category for a powerful apples-to-apples comparison across models. That provides a straight-forward alternative to the UTQG ratings or mileages listed in warranties.

To get the most tread life from your tires, check the pressure monthly. And consult the owner's manual for the proper schedule to rotate the tires and perform wheel alignments. Cut corners and you could lose life from the tires.

Is it worth it to get a road-hazard warranty?

Road-hazard warranties cover part or all of the expense of replacing a tire damaged while in use. Many major tire retailers offer coverage either free or for a fee (an average of about \$17 per tire, according to our survey). Some tire manufacturers also offer hazard warranties. (In our survey, more members got a road-hazard warranty free with the purchase of their tires than paid for it.) Road-hazard protection can come in handy,



KNOW YOUR TIRE TYPES

ALL-SEASON All-season tires are the most common type. They're used on cars, minivans, SUVs, and trucks. They're designed to handle most conditions, including dry and wet pavement and light to moderate snow.

PERFORMANCE ALL-SEASON Performance all-season tires provide year-round grip tuned for enthusiastic driving. They are a step up from regular all-season tires, placing more emphasis on handling.

ULTRA-HIGH-PERFORMANCE ALL-SEASON These tires are commonly fit to upscale sedans or sporty vehicles. These tires are a significant step up from performance all-season tires, delivering higher levels of dry and wet grip and handling, but they give up some winter traction and their tread life is shorter than that of performance all-season tires.

ALL-SEASON TRUCK These are designed to handle the service demands of SUVs and light-duty pickups. They are well-suited for most conditions, including dry and wet pavement and light to moderate snow.

WINTER/SNOW Tires in this category have a tread designed for better grip on snow and ice than what all-season tires provide, and many have a softer rubber compound that remains flexible in extremely cold temperatures.

especially if you have a history of getting flats. Seek this as a perk from your tire retailer, but avoid paying extra unless you get a great deal.

It should be noted that almost all tires carry some form of basic warranty from the manufacturer for defects. They're also referred to as materials and workmanship warranties. The coverage is typically limited to a specific time period or level of wear.

Do I really need a four-wheel alignment with a purchase?

Yes. An alignment, which promotes even treadwear, is key to making your tires last. This should be done when you buy a set of tires, and in accordance with the maintenance schedule in your car owner's manual. Some tire retailers offer this as a free service.

Should I buy all-season or winter/snow tires?

Most new cars come with all-season tires, a type engineered to provide good, year-round performance.

Winter/snow tires, designated by a mountain/snowflake symbol on the sidewall, are specially crafted to provide optimum traction in cold temperatures and have tread designed specifically for gripping snow. They are ideal for those who must travel through harsh, snowy conditions. But they typically have a shorter tread life, and their grip on cleared roads is typically not as good as that of all-season tires. Winter/snow tires should be installed as a set of four just for the rough winter months, and traditional all-seasons used for the rest of the year.

A subcategory of tires called all-weather provides the balanced performance of all-seasons, but with enhanced winter grip. They also have the mountain/snowflake symbol denoting winter grip, yet they have the benefit of not needing to be changed seasonally. The all-weather tires we tested are footnoted in the ratings.



Most & Least Satisfying Tire Retailers

A wide range of vendors, from big-box walk-in stores to online retailers, sell tires for cars, SUVs, and trucks. Our most recent survey of CR members, covering about 36,000 tire purchase and/or installation experiences, shows the importance of choosing the right retailer. Ninety percent of tire buyers said they were highly satisfied with their purchase, and 88 percent were highly satisfied with the installation. But there were clear differences among the retailers, with the top-rated ones pulling ahead on positive measures for sales staff, installation time, free perks, and checkout ease. The survey covered purchases from fall 2017 to fall 2018. (All-Access and Digital members can find detailed ratings at CR.org/tirestores1219.)

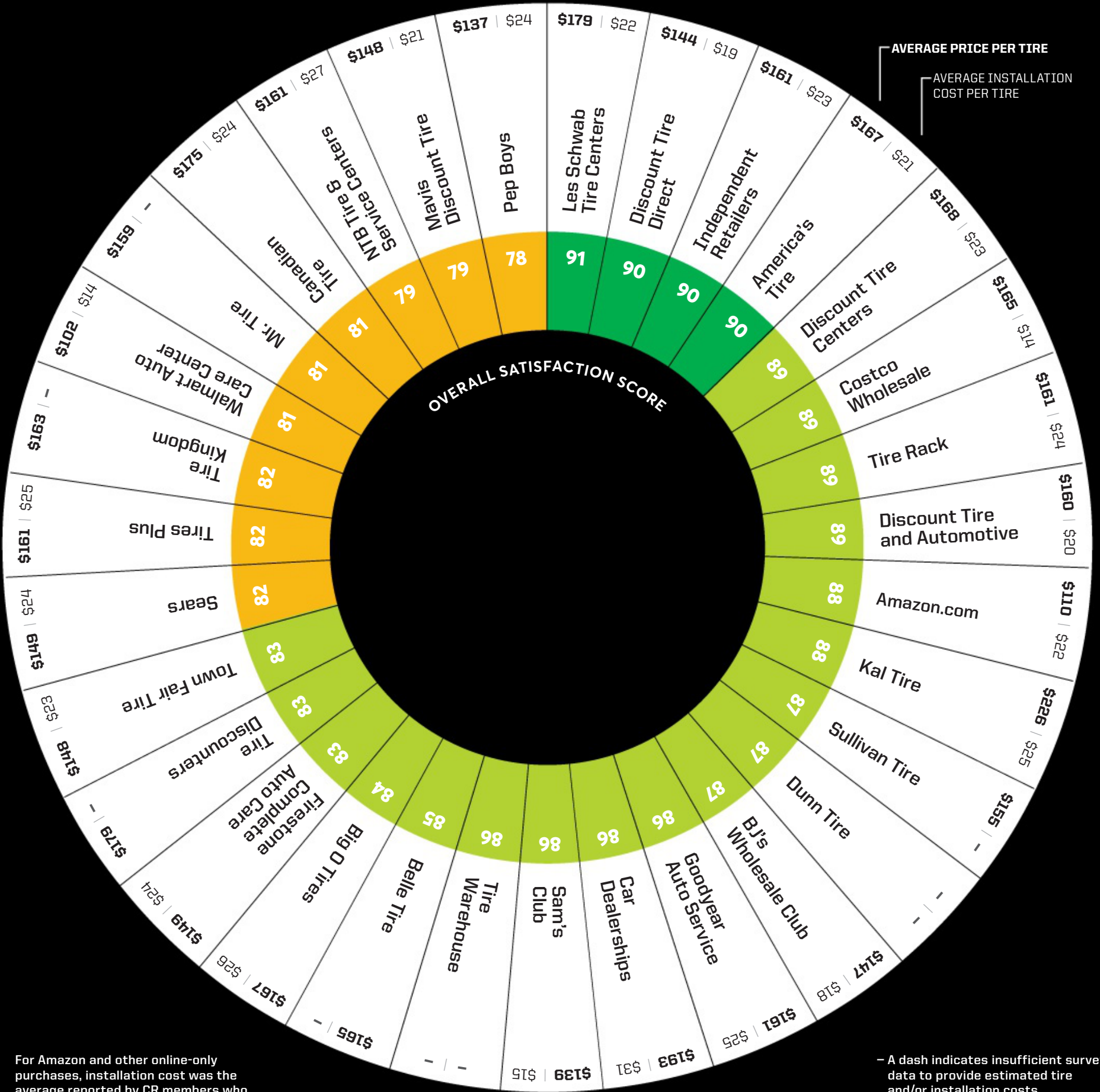

AVERAGE PRICE PER TIRE
AVERAGE INSTALLATION COST PER TIRE

For Amazon and other online-only purchases, installation cost was the average reported by CR members who used a third-party installer.

- A dash indicates insufficient survey data to provide estimated tire and/or installation costs.

Ratings **Traction Action** Winter and summer tires are designed for specific times of the year, and all-season tires provide traction all year long.

Brand + Model	Overall Score	Price	Speed Rating	Three-Season Driving				Winter Driving		Comfort		Other	
				Dry braking	Wet braking	Handling	Hydroplaning resistance	Snow traction	Ice braking	Ride	Noise	Rolling resistance	Tested tread life (miles)
PERFORMANCE WINTER/SNOW													
✓ Vredestein Wintrac Pro	78	\$180	W	↑	↓	↑	↑	↑	↑	↑	↓	↓	NA
✓ Michelin Pilot Alpin PA4	72	\$190	V	↑	↑	↑	↑	↑	↑	↓	↓	↓	NA
Nexen Winguard Sport 2	71	\$129	V	↓	↓	↓	↑	↑	↑	↓	↑	↓	NA
Yokohama Blue Earth Winter V905	70	\$182	W	↑	↓	↓	↑	↑	↑	↓	↓	↓	NA
Hankook Winter I*cept Evo2	70	\$156	V	↓	↓	↓	↑	↑	↑	↓	↑	↓	NA
Bridgestone Blizzak LM001	67	\$189	V	↓	↓	↓	↑	↑	↑	↓	↑	↓	NA
Toyo Observe GSi-6 HP	66	\$200	V	↓	↓	↓	↑	↑	↑	↑	↓	↓	NA
Pirelli Winter Sottozero 3	66	\$147	V	↑	↓	↓	↑	↑	↑	↓	↓	↓	NA
ULTRA-HIGH-PERFORMANCE ALL-SEASON													
Goodyear Eagle Exhilarate	68	\$159	Y	↑	↑	↑	↑	↓	↑	↓	↑	↓	45,000
✓ Michelin Pilot Sport A/S 3+	66	\$159	Y	↑	↑	↑	↑	↓	↓	↓	↓	↓	55,000
✓ General G-Max AS-05	66	\$112	W	↑	↓	↑	↑	↓	↓	↓	↑	↓	65,000
BFGoodrich g-Force Comp-2 A/S	66	\$126	W	↑	↓	↑	↑	↑	↑	↓	↓	↓	65,000
✓ Vredestein Quatrac Pro [Ⓜ]	66	\$151	Y	↑	↓	↑	↑	↑	↑	↓	↑	↓	60,000
Pirelli P Zero All Season Plus	64	\$144	Y	↑	↓	↑	↑	↓	↓	↓	↑	↓	55,000
Continental ExtremeContact DWS06	64	\$148	Y	↑	↑	↑	↑	↓	↓	↓	↑	↓	50,000
Bridgestone Potenza RE980AS	63	\$172	W	↑	↑	↑	↑	↓	↓	↓	↑	↓	40,000
Kumho Ecsta PA51	62	\$134	W	↑	↓	↑	↑	↓	↓	↓	↑	↓	50,000
Cooper Zeon RS3-G1	61	\$119	Y	↑	↓	↑	↑	↓	↑	↓	↓	↓	55,000
Yokohama Advan Sport A/S	60	\$120	Y	↑	↓	↓	↑	↓	↓	↓	↑	↓	75,000
Hankook Ventus S1 Noble 2	57	\$128	W	↑	↓	↓	↑	↓	↓	↓	↓	↓	55,000
Nexen N'Fera AU7	56	\$114	W	↑	↓	↓	↑	↓	↓	↓	↑	↓	45,000
Nitto Motivo	54	\$124	W	↑	↓	↓	↑	↓	↓	↓	↓	↓	60,000
Atlas Force UHP	54	\$95	Y	↑	↓	↑	↑	↓	↓	↓	↑	↓	40,000
Nokian zLine A/S	50	\$102	W	↑	↓	↓	↑	↓	↓	↓	↑	↓	55,000
Laufenn S Fit AS	50	\$109	W	↑	↓	↓	↑	↓	↓	↓	↑	↑	60,000
Vogue Tyre Signature V	49	\$118	W	↑	↓	↓	↑	↓	↑	↓	↑	↓	45,000
Uniroyal Tiger Paw GTZ A/S 2	48	\$105	W	↑	↓	↓	↑	↓	↓	↓	↑	↓	35,000
Ironman iMove Gen2 AS	48	\$65	W	↑	↓	↑	↑	↓	↓	↓	↓	↓	35,000
Sumitomo HTR A/S PO2	47	\$94	W	↑	↓	↓	↑	↓	↓	↓	↑	↓	35,000
ULTRA-HIGH-PERFORMANCE SUMMER													
✓ Michelin Pilot Sport 4s	76	\$185	Y	↑	↑	↑	↑	NA	NA	↓	↑	↓	40,000
✓ Continental ExtremeContact Sport	75	\$170	Y	↑	↑	↑	↑	NA	NA	↓	↑	↓	40,000
✓ General G-Max RS	75	\$104	Y	↑	↑	↑	↑	NA	NA	↓	↑	↓	45,000
Pirelli P Zero PZ4	73	\$119	Y	↑	↑	↑	↑	NA	NA	↓	↑	↓	30,000
Falken Azenis FK510	73	\$115	Y	↑	↑	↑	↑	NA	NA	↓	↑	↓	35,000
Yokohama Advan Fleva V701	72	\$129	W	↑	↓	↑	↑	NA	NA	↓	↑	↑	55,000
GT Radial Champiro HPY	71	\$85	Y	↑	↓	↑	↑	NA	NA	↓	↑	↓	45,000

Brand + Model	Overall Score	Price	Speed Rating	Three-Season Driving				Winter Driving		Comfort		Other	
				Dry braking	Wet braking	Handling	Hydroplaning resistance	Snow traction	Ice braking	Ride	Noise	Rolling resistance	Tested tread life (miles)
ULTRA-HIGH-PERFORMANCE SUMMER <i>Continued</i>													
Dunlop Sport Maxx RT2	71	\$124	Y	↑	↑	↑	↑	NA	NA	↓	↑	↓	35,000
Firestone Firehawk Indy 500	70	\$100	W	↑	↓	↑	↑	NA	NA	↓	↑	↓	40,000
Hankook Ventus V12 Evo2	70	\$121	Y	↑	↓	↑	↑	NA	NA	↓	↑	↓	40,000
Bridgestone Potenza S007A	67	\$152	Y	↑	↓	↑	↑	NA	NA	↓	↑	↓	40,000
Bridgestone Potenza S001	67	\$176	Y	↑	↓	↑	↑	NA	NA	↓	↓	↓	35,000
Bridgestone RE-71R	67	\$170	Y	↑	↓	↑	↑	NA	NA	↓	↓	↓	25,000
Nexen N'Fera SU1	66	\$109	Y	↑	↓	↑	↑	NA	NA	↓	↑	↓	40,000
Toyo Proxes Sport	66	\$121	Y	↑	↑	↑	↑	NA	NA	↓	↑	↓	30,000
Yokohama Advan Sport V105	65	\$229	Y	↑	↓	↑	↑	NA	NA	↓	↑	↓	40,000
Sumitomo HTR ZIII	63	\$105	Y	↑	↓	↑	↑	NA	NA	↓	↓	↓	40,000
Yokohama S.drive	60	\$118	W	↑	↓	↓	↑	NA	NA	↓	↓	↓	40,000
Sentury UHP	59	\$60	W	↑	↓	↓	↑	NA	NA	↓	↑	↓	60,000
Achilles ATR Sport	58	\$64	W	↑	↓	↓	↑	NA	NA	↓	↑	↓	45,000
BFGoodrich g-Force Sport Comp-2	58	\$129	W	↑	↓	↑	↑	NA	NA	↓	↓	↓	40,000
Nitto NT555 G2	58	\$134	W	↑	↓	↓	↑	NA	NA	↓	↑	↓	65,000
Armstrong Blu-Trac HP	57	\$149	Y	↑	↓	↓	↑	NA	NA	↓	↑	↓	40,000
ALL-SEASON													
✓ General Altimax RT43 (T)	70	\$87	T	↑	↓	↑	↑	↑	↑	↓	↑	↑	80,000
✓ Michelin Defender T+H	67	\$115	H	↑	↓	↑	↑	↑	↓	↓	↑	↓	90,000
Continental TrueContact Tour	66	\$97	T	↓	↓	↓	↑	↑	↓	↓	↑	↑	95,000
Falken Sincera SN201 A/S	66	\$79	T	↑	↓	↓	↑	↑	↑	↓	↑	↑	80,000
Falken Sincera SN250 A/S (T)	66	\$81	T	↑	↓	↓	↑	↑	↓	↓	↑	↑	80,000
Nexen Aria AH7 (T)	66	\$91	T	↑	↓	↓	↑	↑	↓	↓	↑	↑	90,000
Yokohama Avid Ascend (T)	65	\$92	T	↑	↓	↓	↑	↑	↓	↑	↑	↑	100,000
BFGoodrich Advantage T/A Sport (T)	63	\$88	T	↑	↓	↓	↑	↑	↓	↓	↓	↓	75,000
Hankook Kinergy PT	63	\$92	T	↑	↓	↑	↑	↑	↓	↓	↑	↓	80,000
Kumho Solus TA11	61	\$80	T	↑	↓	↓	↑	↑	↓	↓	↑	↑	75,000
Pirelli P4 Four Seasons Plus	60	\$108	T	↑	↓	↓	↑	↑	↑	↓	↑	↑	85,000
Bridgestone Ecopia EP422 Plus	60	\$113	T	↑	↓	↓	↑	↓	↓	↓	↑	↑	70,000
Toyo Versado Noir	60	\$100	H	↑	↓	↓	↑	↑	↓	↓	↑	↑	75,000
PERFORMANCE ALL-SEASON													
✓ Michelin CrossClimate +	75	\$171	W	↑	↑	↑	↑	↑	↑	↑	↑	↑	75,000
✓ Continental PureContact LS	71	\$128	V	↑	↓	↑	↑	↑	↑	↓	↑	↓	90,000
General Altimax RT43 (V)	66	\$99	V	↑	↓	↑	↑	↑	↑	↓	↑	↑	70,000
Goodyear Assurance WeatherReady	64	\$142	V	↓	↓	↑	↑	↑	↓	↓	↑	↓	75,000
Michelin Premier A/S	64	\$158	V	↑	↓	↑	↑	↓	↓	↓	↑	↓	80,000
Pirelli Cinturato P7 All Season Plus	64	\$140	V	↑	↓	↑	↑	↓	↓	↓	↑	↑	70,000
Vredestein Quatrac 5	62	\$104	V	↓	↓	↓	↑	↑	↓	↓	↑	↑	50,000

Ratings > Traction Action *Continued*

Brand + Model	Overall Score	Price	Speed Rating	Three-Season Driving				Winter Driving		Comfort		Other	
				Dry braking	Wet braking	Handling	Hydroplaning resistance	Snow traction	Ice braking	Ride	Noise	Rolling resistance	Tested tread life (miles)
PERFORMANCE ALL-SEASON <i>Continued</i>													
Atlas Force HP	61	\$53	V	↑	↓	↑	↑	↓	↓	↓	↓	↑	65,000
Falken Sincera SN250 A/S (V)	61	\$94	V	↑	↓	↓	↑	↑	↓	↓	↑	↓	75,000
BFGoodrich Advantage T/A Sport (V)	60	\$106	V	↑	↓	↑	↑	↓	↓	↓	↑	↓	80,000
Firestone Firehawk AS	60	\$92	V	↑	↓	↓	↑	↓	↓	↓	↑	↓	60,000
WINTER/SNOW													
✓ Cooper Discoverer True North	70	\$92	H	↓	↓	↓	↓	↑	↑	↑	↑	↓	NA
✓ Hankook Winter I*cept iZ2	70	\$101	T	↓	↓	↓	↑	↑	↑	↑	↑	↑	NA
✓ Continental WinterContact SI	69	\$121	H	↓	↓	↓	↑	↑	↑	↑	↑	↑	NA
✓ Michelin X-Ice XI3	68	\$98	H	↓	↓	↓	↑	↑	↑	↓	↑	↑	NA
✓ Nokian Hakkapeliitta R3	68	\$147	R	↓	↓	↓	↑	↑	↑	↓	↓	↑	NA
General Altimax Arctic 12	67	\$84	T	↓	↓	↓	↑	↑	↑	↓	↑	↓	NA
Bridgestone Blizzak WS80	67	\$109	H	↓	↓	↓	↑	↑	↑	↓	↓	↑	NA
Nexen Winguard Ice Plus	66	\$99	T	↓	↓	↓	↑	↑	↑	↑	↑	↓	NA
Falken HS449 Eurowinter	64	\$91	H	↓	↓	↓	↑	↑	↑	↑	↓	↓	NA
Dunlop Winter Maxx 2	63	\$140	T	↓	↓	↓	↑	↑	↑	↑	↓	↓	NA
ALL-SEASON TRUCK													
✓ Continental CrossContact LX20 EcoPlus	74	\$153	T	↑	↓	↓	↑	↑	↓	↑	↑	↑	65,000
✓ Michelin Premier LTX	74	\$181	H	↑	↓	↓	↑	↓	↑	↓	↑	↑	40,000
✓ Firestone Destination LE 2	72	\$148	S	↓	↓	↓	↑	↑	↑	↓	↑	↑	65,000
✓ Pirelli Scorpion Verde All Season Plus	72	\$177	T	↑	↓	↓	↑	↑	↓	↓	↑	↑	65,000
✓ Michelin Defender LTX M/S	72	\$170	T	↓	↓	↓	↑	↑	↑	↓	↑	↑	85,000
Cooper Discoverer SRX	70	\$163	T	↓	↓	↓	↑	↑	↓	↑	↑	↑	55,000
General Grabber HTS60	70	\$136	T	↑	↓	↓	↑	↓	↓	↑	↑	↓	65,000
Kumho Crugen HT51	68	\$107	T	↓	↓	↓	↑	↑	↑	↓	↑	↑	60,000
Hankook Dynapro HT	68	\$127	T	↓	↓	↓	↑	↓	↑	↓	↑	↑	70,000
Nexen Roadian HTX RH5	68	\$122	H	↑	↓	↓	↑	↓	↓	↓	↑	↑	70,000
Laufenn X Fit HT	68	\$120	T	↑	↓	↓	↑	↓	↑	↑	↑	↑	70,000
Goodyear Wrangler Fortitude HT	68	\$198	T	↓	↓	↓	↑	↑	↓	↓	↓	↑	65,000
Bridgestone Dueler LTH	66	\$175	T	↓	↓	↓	↑	↓	↓	↓	↑	↓	75,000
Nokian WR G3 SUV [Ⓜ]	66	\$124	V	↓	↓	↓	↑	↑	↑	↓	↓	↑	55,000
Bridgestone Dueler H/L Alenza Plus	66	\$160	T	↓	↓	↓	↑	↓	↓	↓	↑	↑	65,000
Uniroyal Laredo Cross Country Tour	64	\$115	T	↓	↓	↓	↑	↑	↑	↓	↑	↓	65,000
➤ All-Access and Digital members can find the latest, complete ratings at CR.org/tires .													

HOW WE TEST: **Speed Rating** denotes a tire's maximum speed when carrying the load defined by the load index, represented by letters: S (112 mph), T (118 mph), H (130 mph), V (149 mph), W (168 mph), Y (186 mph), and ZR (149-plus mph). **Braking** tests on ice are from

10 mph; on dry and wet pavement, from 60 mph. **Handling** combines steering feel with how well a tire performed in the wet-handling test and an emergency-handling maneuver. **Hydroplaning resistance** denotes resistance to skimming along the surface of standing

water. **Snow traction** denotes how far a vehicle has to travel to accelerate from 5 to 20 mph on flat, packed snow. **Ride** and **Noise** are evaluated subjectively on rough and smooth roads. **Rolling resistance**, as measured by a dynamometer, is a factor in fuel

economy. **Tested tread life** indicates wear potential based on our 16,000- or 20,000-mile vehicle driving test. **Overall Score** is based on the performance of the tire in all our tests. **Price** is how much we paid for a single tested tire.



ROAD TEST

WE CONDUCT 50+ TESTS ON EACH VEHICLE AT OUR 327-ACRE AUTO TEST CENTER. FOR COMPLETE ROAD TESTS, ALL-ACCESS MEMBERS CAN GO TO [CR.ORG/CARS](https://www.cars.com).



LUXURY MIDSIZED CARS

Audi A6

Impressive Sedan With a Balky Powertrain

84

OVERALL SCORE

ROAD-TEST SCORE 93

HIGHS Handling, braking, quiet interior, seat comfort, fit and finish

LOWS Uneven power delivery, scant interior storage

POWERTRAIN 248-hp, 2.0-liter 4-cylinder turbocharged engine; 7-speed dual-clutch automatic transmission; all-wheel drive

FUEL 26 mpg on premium fuel

PRICE AS TESTED \$59,390

MIDSIZED 3-ROW SUVs

Ford Explorer

Doesn't Reach New Heights

69

OVERALL SCORE

ROAD-TEST SCORE 78

HIGHS Agility, controls, interior room

LOWS Ride, low-speed transmission shifts, price

POWERTRAIN 300-hp, 2.3-liter 4-cylinder turbocharged engine; 10-speed automatic transmission; all-wheel drive

FUEL 21 mpg on regular fuel

PRICE AS TESTED \$49,940

AUDI'S A6 IS among the top midsize luxury cars we've tested. It has class-leading fuel economy, lively handling, user-friendly high-tech features, and an elegant interior. Yet its low-speed manners and less than plush ride detract from the road-test score.

The four-cylinder turbocharged engine and dual-clutch automatic transmission shine during spirited driving. At the same time, the Audi's 26 mpg overall is tied with the BMW 530i for the best fuel economy in the category.

The sedan's sharp steering responds quickly, contributing to the A6's nimble handling characteristics. And the superb braking performance instills driver confidence.

Longer drives are a treat in the A6's quiet cabin, with premium materials of high-quality wood, leather, and

aluminum trim. The front and rear seats are firm and supportive, and visibility is good all around.

The two touch screens that control the audio, phone, and navigation functions might intimidate drivers at first, but we found them quite logical to use.

A bigger concern: The Audi's hesitation when pulling away from a stop or trying to jump into a gap in traffic at urban speeds is frustrating.

Passengers can feel the texture of the road surface even though the suspension filters out harsh impacts from potholes and ruts.

Forward collision warning (FCW) and automatic emergency braking (AEB) are standard, but blind spot warning (BSW) and rear cross traffic warning (RCTW) are part of option packages.

WE LIKE THE redesigned Explorer's agile handling, quiet cabin, and spacious first- and second-row seats. But the driving experience is marred by a clunky transmission, noisy engine, and stiff-edged ride. These faults hurt the Explorer's CR road-test score, earning it a middling rank among the three-row midsize SUVs we've tested. Further, some comparably equipped rivals, such as the Hyundai Palisade and Subaru Ascent, cost about \$6,000 less.

The Explorer's rear-drive-based platform contributes to its newfound handling chops and improved tow rating of 5,300 pounds on our test vehicle. The all-wheel-drive model proved adept through corners, with quick-to-respond steering and a firm suspension that gave drivers confidence.

Most people will find it easy to find a comfortable driving position, thanks to plenty of

headroom, a wide range of seat adjustments, a large left footrest, and well-padded armrests. The controls are simple and the infotainment system is intuitive. The cabin stays hushed even at highway speeds, although the turbo four-cylinder engine gets raspy when accelerating.

There's plenty of oomph to get up to speed quickly, yet at 21 mpg overall, the Explorer doesn't have a fuel-economy advantage over some of its smoother V6 competitors. Plus, low-speed shifts from the 10-speed automatic are noticeably rough. The ride is less compliant than many rivals', transmitting bumps in the road into the cabin. The SUV's fit and finish feels a bit cheap, with too much hard plastic. It comes standard with FCW, AEB with pedestrian detection, BSW, lane departure warning (LDW), and lane keeping assist (LKA).



MIDSIZED 3-ROW SUVs

Hyundai Palisade

Strong, New Challenger

84

OVERALL SCORE

THE ALL-NEW, THREE-ROW Palisade is an extremely functional family vehicle, distinguished by a no-nonsense powertrain and thoughtfully designed interior. It joins the Kia Telluride (also built by Hyundai) in disrupting the rankings within this popular vehicle class.

The Palisade's V6 engine is smoother and punchier than some of its rivals' turbo four-cylinders. This quiet engine provides effortless acceleration and returns a reasonable 21 mpg overall.

The SUV does a decent job of absorbing bumps, though the large 20-inch wheels—common on the Palisade—compromise ride comfort. Handling is marred by steering that's not very responsive, and there's body roll during routine driving. But the Palisade we tested demonstrated tenacious grip and well-tuned

ROAD-TEST SCORE 88

HIGHS Powertrain, interior room, access, quiet cabin

LOWS Agility, gear selector

POWERTRAIN 291-hp, 3.8-liter V6 engine; 8-speed automatic transmission; all-wheel drive

FUEL 21 mpg on regular fuel

PRICE AS TESTED \$43,415

stability control through our avoidance maneuver.

The vehicle can seat seven or eight people depending on whether it has a second-row bench or two separate seats. Test drivers of various sizes found it quite easy to get comfortable. The roomy cabin has convenient features, such as readily accessible USB ports for the rear passengers and a handy release for the second-row seat to allow access to the third row. The infotainment system and most controls are simple to use, except for the push-button gear selector.

Standard advanced safety features include FCW, AEB with pedestrian detection, LKA, and a driver attention monitor. But buyers should note that BSW is only optional. This key safety feature is standard on the Telluride, which could make the Kia the smarter buy.



COMPACT ELECTRIC VEHICLES

Nissan Leaf Plus

More Range, but Still Outclassed

72

OVERALL SCORE

NISSAN NOW SELLS two versions of the Leaf EV. The new Leaf Plus gets a bigger, 62-kWh battery and has an EPA-estimated range of 215 miles. That's a big difference compared with the standard Leaf's 40-kWh battery and 150-mile range, and it puts the range of the Leaf Plus closer to similarly priced competitors.

But when it comes to everyday use, the Plus is outclassed by "affordable" EVs, such as the Hyundai Kona Electric and Kia Niro EV.

The larger battery gives the Leaf Plus its extra range, but it takes 10.5 hours to charge from empty. Still, the more powerful motor gives it a quicker 0-to-60 mph time by 1 second. Both versions have the same humdrum handling, and they feel stiff over sharp bumps.

The compact hatchback's cargo area is deep and

ROAD-TEST SCORE 73

HIGHS Low running costs, no tailpipe emissions, quick and quiet acceleration

LOWS Range, handling, driving position, long charging times

POWERTRAIN 214-hp, electric motor; 1-speed direct transmission; front-wheel drive

RANGE 215 miles

PRICE AS TESTED \$44,330

roomy. But our test car's optional Bose audio system creates a lump that takes significant space from the cargo floor.

The elevated driving position provides a good view of the road ahead. But we found it a rather awkward fit because the steering wheel doesn't telescope for reach, and the center console rubs against the driver's right knee. In addition, the rear seat is snug.

An 8-inch touch screen is standard on the Leaf Plus. However, drivers can only access EV-specific data and customize the safety features through a smaller display in the instrument panel, which we found awkward to use.

FCW and AEB come standard, but BSW is optional. The optional ProPilot Assist system can help keep the car in its lane and adjust speed to keep pace with traffic.

Ratings > **Eclectic Offerings** Consumer Reports' extensive testing reveals that even high-scoring vehicles can have some flaws.

Make + Model	Overall Score	Price	Survey Results		Safety	Road-Test Results										
			Predicted reliability	Owner satisfaction		Crash prevention	Road-test score	Overall mpg	Acceleration 0-60 mph, sec.	Dry braking 60-0 mph, ft.	Avoidance-maneuver speed, mph	Routine handling	Ride	Noise	Seat comfort front/rear	Controls
MID-SIZED SUVs (3-ROW)																
Subaru Ascent Limited	96	\$43,867	↑	↑	Std. ↑	93	22	8.0	129	52.0	↓	↑	↑	↑ / ↑	↑	40.5
Kia Telluride EX	90	\$40,855	↓	↑	Std. ↑	97	21	7.2	127	53.5	↓	↑	↑	↑ / ↑	↑	47.5
Toyota Highlander XLE (V6) (2019)	85	\$41,169	↑	↑	Std. ↑	82	22	7.4	134	48.5	↓	↑	↑	↑ / ↑	↑	40.5
Hyundai Palisade SEL	84	\$43,415	↓	↑	Std. ↑	88	21	7.1	132	52.5	↓	↑	↑	↑ / ↑	↑	47.5
Kia Sorento EX (V6)	78	\$41,925	↑	↑	Opt.	78	22	8.1	137	49.0	↓	↑	↑	↑ / ↑	↑	37.5
Mazda CX-9 Touring	78	\$40,470	↑	↓	Std. ↓	80	22	7.9	139	50.0	↑	↑	↑	↑ / ↑	↓	34.0
Honda Pilot EX-L	74	\$40,655	↓	↓	Std. ↑	80	20	7.5	136	49.5	↓	↑	↑	↑ / ↑	↓	48.0
Ford Explorer XLT (2.3T)	69	\$49,940	↓	↑	Std. ↑	78	21	7.4	136	51.5	↑	↓	↑	↑ / ↑	↑	44.5
Nissan Pathfinder SL	66	\$40,470	↓	↓	Std. ↑	72	18	7.7	137	47.0	↓	↑	↑	↑ / ↑	↑	39.5
Dodge Durango GT (V6)	65	\$43,525	↓	↑	Opt.	83	18	8.3	134	48.0	↓	↑	↑	↑ / ↑	↑	44.0
Chevrolet Traverse Premier	65	\$49,945	↓	↑	Opt.	95	20	7.3	130	50.5	↑	↑	↑	↑ / ↑	↑	54.5
Volkswagen Atlas SEL (V6)	62	\$44,165	↓	↑	Std. ↑	84	20	8.7	135	51.0	↑	↑	↑	↑ / ↑	↑	50.5
LUXURY MID-SIZED CARS																
Lincoln Continental Select (2.7T, AWD)	89	\$55,590	↑	↑	Std. ↑	83	20	6.6	127	51.5	↑	↑	↑	↓ / ↑	↓	2+2
Genesis G80 3.8 (AWD)	84	\$52,450	↑	↑	Std. ↑	89	20	7.2	129	53.0	↑	↑	↑	↑ / ↑	↑	3+1
Audi A6 Premium Plus (2.0T)	84	\$59,390	↓	↑	Std. ↑	93	26	6.8	129	55.5	↑	↑	↑	↑ / ↑	↓	3+1
Lexus GS 350	83	\$58,858	↑	↑	Std. ↑	83	21	6.2	137	53.5	↑	↑	↑	↑ / ↑	↓	3+1
Infiniti Q70 Luxe	78	\$53,825	↓	↓	Opt.	90	21	5.8	128	54.5	↑	↑	↑	↑ / ↑	↑	3+2
BMW 530i xDrive	71	\$65,210	↓	↑	Std. ↑	94	26	7.2	130	52.5	↑	↑	↑	↑ / ↑	↓	3+1
Acura RLX Tech	71	\$55,345	↓	↓	Std. ↑	75	23	6.5	128	51.5	↓	↓	↑	↑ / ↑	↓	2+3
Cadillac CT6 Luxury (3.6, AWD)	65	\$64,485	↓	↓	Std. ↑	95	22	6.5	125	52.0	↑	↑	↑	↑ / ↑	↓	3+2
Mercedes-Benz E300 (4MATIC)	65	\$69,585	↓	↓	Std. ↑	85	24	7.1	128	54.5	↑	↑	↑	↑ / ↓	↓	2+2
Volvo S90 T6 Momentum (AWD)	56	\$61,855	↓	↑	Std. ↑	73	23	7.2	130	52.5	↑	↓	↑	↑ / ↑	↓	2+2
Jaguar XF Prestige (V6, AWD)	46	\$66,586	↓	↓	Opt.	83	21	5.8	128	51.0	↑	↑	↑	↑ / ↑	↓	2+1
COMPACT ELECTRIC VEHICLES <small>Ⓜ Indicates miles-per-gallon equivalent (MPGe).</small>																
Kia Niro EV EX Premium	79	\$47,270	↑	↑	Std. ↑	81	112 [Ⓜ]	6.8	135	52.5	↑	↓	↑	↑ / ↓	↑	2+2
Hyundai Kona Electric Limited	78	\$42,330	↑	↑	Std. ↑	76	120 [Ⓜ]	6.6	135	53.5	↑	↓	↑	↑ / ↓	↓	1+1
Nissan Leaf SL Plus	72	\$44,330	↓	↑	Std. ↑	73	104 [Ⓜ]	7.0	139	52.5	↓	↓	↑	↑ / ↓	↑	3+0
Chevrolet Bolt Premier	71	\$43,155	↓	↑	Opt.	76	119 [Ⓜ]	6.8	138	53.0	↑	↓	↑	↓ / ↓	↑	2+0
Nissan Leaf SL	64	\$38,115	↓	↑	Std. ↑	62	112 [Ⓜ]	8.0	141	53.5	↓	↓	↑	↑ / ↓	↑	3+0

HOW WE TEST: Recommended models did well in our Overall Score. This factors in Road-Test Results, Predicted reliability, Owner satisfaction, and Safety, which includes crash-test results and

the availability of crash prevention features, such as forward collision warning and automatic emergency braking, pedestrian detection, and blind spot warning. NA means no such

safety system is offered; Opt. means it's available but not as standard equipment. We also rate models from ↓ to ↑ based on how many advanced safety features come standard.

We deduct points if a model's gear selector lacks fail-safes. Digital or All-Access members can go to [CR.org/cars](https://www.consumerreports.org/cars) for complete ratings.

Index

THIS INDEX LISTS ALL THE ARTICLES PUBLISHED IN THE MAGAZINE OVER THE PAST 12 MONTHS (INCLUDING THIS ISSUE). FOR INDEXES COVERING THE PAST FIVE YEARS, GO TO CR.ORG/5YEARINDEX.

A

Air conditioners	
ratings	
central	Jun 19, 21
window/portable	Jun 19, 23
time line	Jun 19, 14
window	Jun 19, 19
Air fryers	Sep 19, 42
Airfare savings	Sep 19, 16
Alexa digital assistant, automotive	Jan 19, 13
Almond milk	Nov 19, 32
Antibiotics in food	Mar 19, 7
Ants, getting rid of in home	Jun 19, 14
Appliances	
coffee brewing	Nov 19, 29
ratings	Nov 19, 26; Nov 19, 30
countertop	Sep 19, 36
energy efficiency	Jun 19, 7
ratings	
countertop	Sep 19, 45
noise	Feb 19, 49
reliability	Aug 19, 28
reliability	Aug 19, 24
Arsenic in bottled water	Jul 19, 19

AUTOMOBILE RATINGS

Audi A6	Dec 19, 59
Audi A8	May 19, 59
Audi E-Tron	Nov 19, 63
BMW 3 Series	Aug 19, 63
BMW X5	Mar 19, 59
BMW X7	Jul 19, 64
BMW Z4	Aug 19, 64
Cadillac XT4	May 19, 59
Cadillac XT6	Nov 19, 63
Chevrolet Blazer	Jun 19, 60
Chevrolet Silverado	Mar 19, 60
Ford Edge	May 19, 60
Ford Explorer	Dec 19, 59
Ford Ranger	Jul 19, 63
Genesis G70	Mar 19, 59
Honda Passport	Jun 19, 60
Hyundai Kona Electric	Sep 19, 63
Hyundai Palisade	Dec 19, 60
Hyundai Santa Fe	Jan 19, 59
Hyundai Tucson	Mar 19, 60
Hyundai Veloster	Jan 19, 60
Jaguar I-Pace	Jul 19, 63
Jeep Gladiator	Oct 19, 64
Kia Forte	Feb 19, 60
Kia Niro EV	Oct 19, 63
Kia Soul	Aug 19, 64
Kia Telluride	Jul 19, 64
Lexus ES	Jan 19, 59
Lexus UX	Jun 19, 59
Mazda3	Aug 19, 63
Mercedes-Benz A-Class	Nov 19, 64
Mercedes-Benz GLE	Sep 19, 64
Nissan Altima	Feb 19, 60
Nissan Leaf Plus	Dec 19, 60
Porsche Cayenne	Feb 19, 59
Ram 1500	Jan 19, 60
Range Rover Evoque	Oct 19, 64
Subaru Crosstrek Hybrid	Oct 19, 63
Subaru Forester	Feb 19, 59
Toyota Corolla	Sep 19, 63
Toyota RAV4	May 19, 60
Hybrid	Sep 19, 64
Volkswagen Arteon	Nov 19, 64
Volvo S60	Jun 19, 59

AUTOMOBILES & AUTO EQUIPMENT

2019 models	Jan 19, 56
Auto repair shops	Feb 19, 52
Automated driving systems	Jan 19, 57
Automotive safety	May 19, 52
Best & worst lists	Apr 19, 20
Best vehicles for life milestones	Mar 19, 50
Brand Report Card	Apr 19, 18
Buying process	Jan 19, 52
Car subscription services	Jan 19, 55
Car washes	Apr 19, 36
Coming in 2019	Apr 19, 28

Electric vehicles	Sep 19, 54; Dec 19, 7
Emissions standards	Feb 19, 7
Extended warranties	Feb 19, 58
Infotainment systems	Jun 19, 34
ratings	Jun 19, 41
Insurance	Nov 19, 48
ratings	Nov 19, 54
Key fob features	Jul 19, 62
Owner satisfaction ratings	Mar 19, 56
Potential deal breakers	Nov 19, 56
Profiles, 2019	Apr 19, 48
Ratings, 2019	Apr 19, 38
Reliability	Apr 19, 86
ratings	Apr 19, 88
Roadsters	
Fiat 124 Spider vs. Mazda MX-5 Miata	Aug 19, 15
Safety systems	
survey findings	Aug 19, 56
for teen drivers	Sep 19, 15
Seat belts	May 19, 55
Self-cleaning cameras	Mar 19, 14
Selling tips	Apr 19, 30
SUVs	
Honda CR-V vs. Toyota RAV4	Jun 19, 13
vs. pickup trucks	Apr 19, 32
Tires	Dec 19, 52
ratings	Dec 19, 56
Top Picks for 2019	Apr 19, 13
Truck underride guards	Jul 19, 7
Used cars	Apr 19, 82; Oct 19, 54
hidden risks and recalls	Jun 19, 52
ratings	Oct 19, 59

B-D

Bedsheets	Mar 19, 32
Blenders	Aug 19, 19
ratings	Aug 19, 20
vacuum	May 19, 13
Botanicals	Dec 19, 26
Bottled water	Nov 19, 36
arsenic in	Jul 19, 19
Breakfast time line	Sep 19, 14
Cable TV	Sep 19, 24
Cameras	Nov 19, 13
Cannabidiol (CBD)	May 19, 44
Car washes	Apr 19, 36
Chicken broth	Mar 19, 15
Cleaning tips	
grills	Sep 19, 14
mattresses	Mar 19, 28
shower heads	Mar 19, 17
windows	May 19, 14
Coconut milk	Nov 19, 32
Coffee	Nov 19, 24
coffee makers	Nov 19, 29
ratings	Nov 19, 26; Nov 19, 30
cold brew	Jul 19, 13; Nov 19, 27
health benefits	Nov 19, 28
Computers	
all-in-one desktop ratings	Dec 19, 25
laptops	Dec 19, 18
ratings	Dec 19, 23
Cookware, stackable	Aug 19, 17
Credit scores	Aug 19, 36
how to improve	Aug 19, 40
Data breaches	
small businesses	Mar 19, 38
Data privacy	Oct 19, 24
children's	Dec 19, 7
Data protection	Aug 19, 7
prescriptions	Mar 19, 47
Data security	Sep 19, 7; Oct 19, 7
Debt	Oct 19, 36
Decking	Aug 19, 17
Deer collisions	Oct 19, 14
Deli meat	Oct 19, 48
Doctor misconduct notification	Jan 19, 7
Drug prices	Jan 19, 46; Jun 19, 7
lowering	Jan 19, 7; Aug 19, 7
Drugstores	Mar 19, 42
Dutch ovens	Sep 19, 13

E-G

Echinacea supplements	Dec 19, 36
Ellipticals	Jan 19, 40
Energy bars for kids	Oct 19, 17
Energy efficiency, appliances	Jun 19, 7
Fast-food chains'	
antibiotic use	Feb 19, 14; Mar 19, 7
Fees	
cable TV	Feb 19, 7
ticket sales	Mar 19, 7
utilities	Aug 19, 7
“What the Fee?!” campaign	Jul 19, 28
Financial tips	Jan 19, 36
Fire safety time line	Oct 19, 14
Flooring	Feb 19, 22
ratings	Feb 19, 24
Food	
bread labeling	Jul 19, 16
breakfast time line	Sep 19, 14
heavy metals in	
fruit juice	Mar 19, 16; May 19, 7
holiday treats	Dec 19, 16
meat labeling	Dec 19, 7
Food processors	Sep 19, 44
Furniture	
tipping hazards	Mar 19, 19; May 19, 7; Sep 19, 7
Generators	Feb 19, 16
ratings	Dec 19, 41
safety	Dec 19, 38
Gifts for \$50 and under	Dec 19, 13
Granola	Aug 19, 14
Grills	Jul 19, 22
buying at Home Depot vs. Lowe's	Jul 19, 24
kamado	Mar 19, 13
ratings	Jul 19, 25
Grocery shopping	Aug 19, 46
delivery services	
ratings	Aug 19, 51
survey	Aug 19, 50

H-I

Headphones, noise-canceling	Nov 19, 14
Health information privacy	Jul 19, 7
Hearing aids	Jun 19, 42
ratings	Jun 19, 50
Home insurance	Sep 19, 48
ratings	Sep 19, 52
Home security systems	Oct 19, 19
ratings	Oct 19, 23
Hot car death prevention	Nov 19, 7
Ice cream	
healthier	May 19, 32
ratings	May 19, 37
time line	May 19, 14
Insect repellents	Jul 19, 54
ratings	Jul 19, 60
Insurance	
auto	Nov 19, 48
ratings	Nov 19, 54
home	Sep 19, 48
ratings	Sep 19, 52

L-P

Laptops	Dec 19, 18
ratings	Dec 19, 23
Lawn mowers and tractors	Jul 19, 40
ratings	Jul 19, 44
reliability	Jul 19, 42
Marijuana	May 19, 50
Mattresses	Mar 19, 24
ratings	Mar 19, 30
Meat, deli	Oct 19, 48
Meat substitutes	Oct 19, 42
Medical billing	
surprise bills	Oct 19, 7
Medical tests	Jan 19, 26
Medicare Part D	Jan 19, 46
Melanoma	Jul 19, 14

Mosquito repellents	Jul 19, 54
Multi-cookers	Sep 19, 38
Net neutrality	Jan 19, 7; Jul 19, 7
Noise	Feb 19, 42
Noise-canceling headphones	Nov 19, 14
Nuts	Feb 19, 18
ratings	Feb 19, 21
Oat milk	Nov 19, 32
Pain relief	Jun 19, 24
Pasta sauces	Jan 19, 20
ratings	Jan 19, 24
Patio tiles	Sep 19, 16
Peanut butter cups	Oct 19, 15
Pedestrian safety	Apr 19, 8
Pest control time line	Jul 19, 14
Pharmacies	Mar 19, 42
ratings	Mar 19, 48
Plant milks	Nov 19, 32
ratings	Nov 19, 34
Printers, reliability	Jun 19, 15
Pyramid schemes	May 19, 7

R-S

Ranges	Nov 19, 16
Recall failings	Dec 19, 42
Refrigerator water filters	Sep 19, 17
Retail memberships	Dec 19, 17
Retirement savings	Jun 19, 7; Oct 19, 36
Robocalls	May 19, 22; Sep 19, 7; Nov 19, 7
Safety standards	Nov 19, 7
Security systems, home	Oct 19, 19
Slow cookers	Sep 19, 41
Smart speakers	Aug 19, 42
privacy	Oct 19, 28
Smartphones	Feb 19, 26
5G service	Aug 19, 16
car infotainment features	Jun 19, 34
ratings	Feb 19, 33
Soy milk	Nov 19, 32
Steam mops	Jul 19, 15
Stuffing	Nov 19, 15
Sunscreens	Jul 19, 46
labeling	Jul 19, 50
ratings	Jul 19, 51
Supermarkets	Aug 19, 46
delivery service survey	Aug 19, 50
ratings	Aug 19, 52
time line	Aug 19, 14
Supplements	Dec 19, 26

T-W

Tankless water heaters	Oct 19, 16
Televisions	
8K	Aug 19, 13
antennas	Sep 19, 32
ratings	Nov 19, 21
shopping for	Nov 19, 18
Thanksgiving time line	Nov 19, 14
Tick protection	Jul 19, 54
Tipping	Feb 19, 34
Toaster ovens	Sep 19, 40
Toothpaste ingredients	Jun 19, 16
Trail mix	Jun 19, 17
Treadmills	Jan 19, 40
ratings	Jan 19, 45
Turmeric supplements	Dec 19, 36
TV streaming	Sep 19, 28
device ratings	May 19, 43; Sep 19, 35
free	May 19, 38
Vacuum blenders	May 19, 13
Vacuums	Sep 19, 19
robotic	Jan 19, 15
Water, bottled	Nov 19, 36
arsenic in	Jul 19, 19
Water filter pitcher ratings	Nov 19, 47
Water heaters, tankless	Oct 19, 16
Whole-wheat pasta	Jan 19, 20
ratings	Jan 19, 23
Windows	May 19, 18
ratings	May 19, 21

Holiday Hoodwinks

These odd offers might make you look twice

Scrooge-y Sale

This stingy discount won't help these "clearance" reindeer fly off the shelves. Submitted by David Onodera, via email



Snow Job?

Here's a waffle maker that may be a true Christmas miracle. Submitted by Cheri Lenhart, via email



Oh, Fudge!

Sometimes you just gotta spell out the whole word. Submitted by Gary Gunderson, Olympia, WA



A Chilly Reception

A perfect solution to make sure your holiday houseguests don't overstay their welcome. Submitted by Beverly Carrigan, Colorado Springs, CO



SHARE

Be on the lookout for goofs and glitches like these. Share them with us—by email at SellingIt@cro.consumer.org or by mail to Selling It, Consumer Reports, 101 Truman Ave., Yonkers, NY 10703—and we might publish yours. Please include key information, such as the publication's name and date.